



BRICK 'HEADZ

40495



Harry Potter



 [LEGO.com/brickheadz](https://www.LEGO.com/brickheadz)

RON WEASLEY™

141

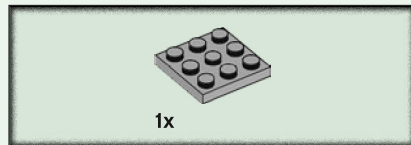
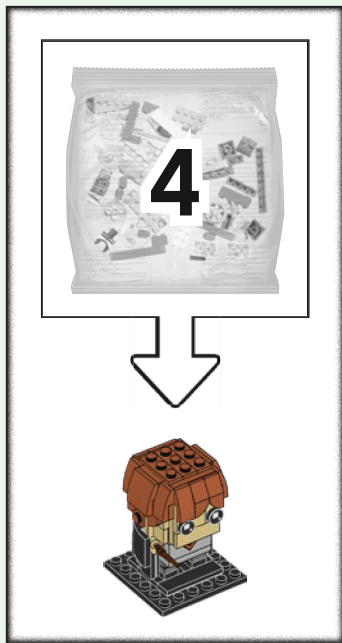

1



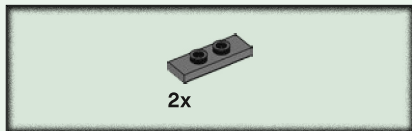

2

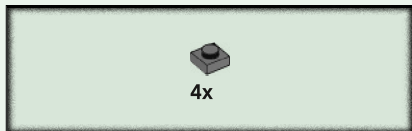
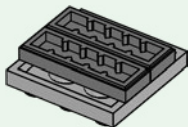

3

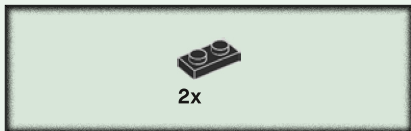
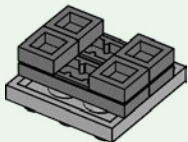

4

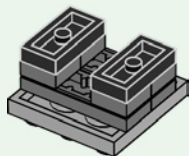

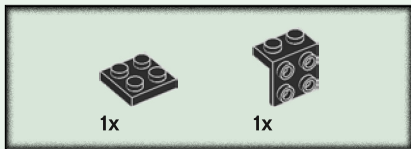

5

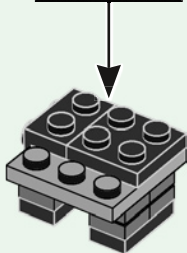
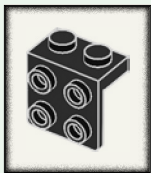

4

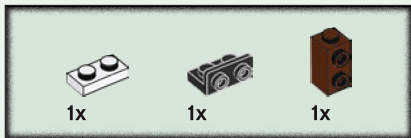

6

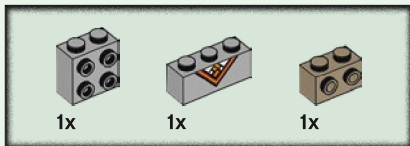
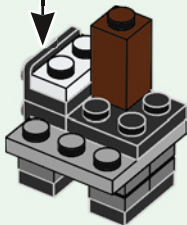
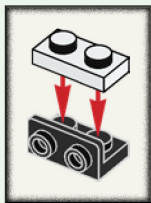

7

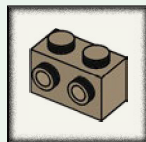

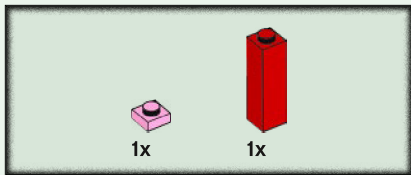

8

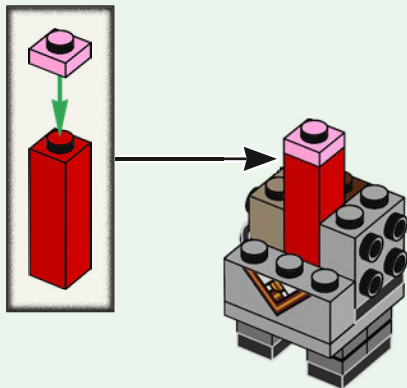

6

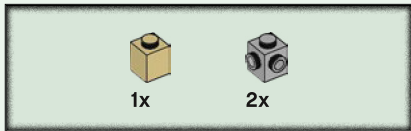

9

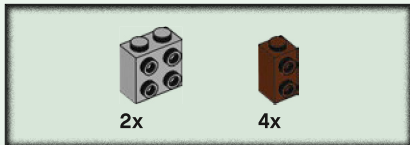
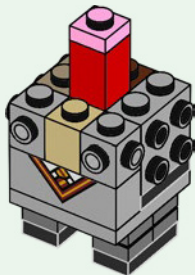

10

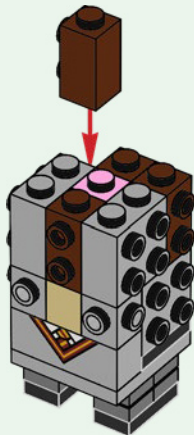

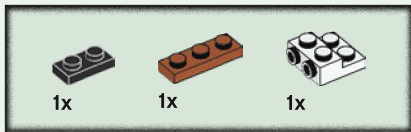

11

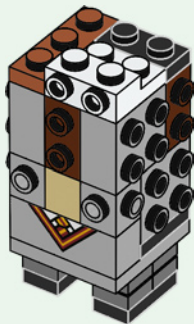

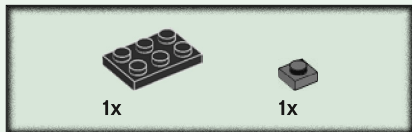

12

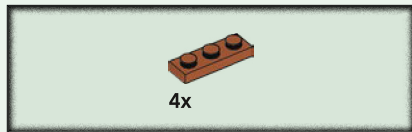
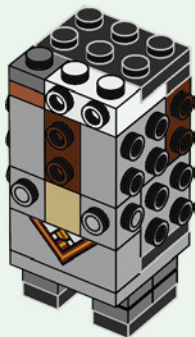

13

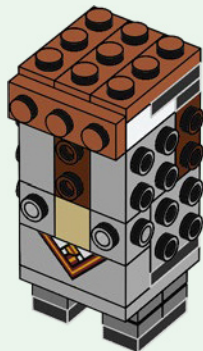

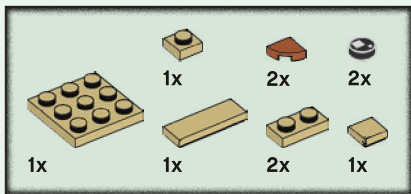

14

1



2

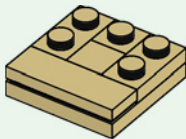

3

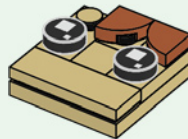

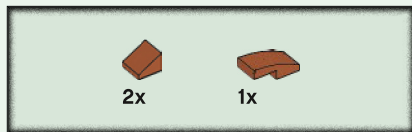
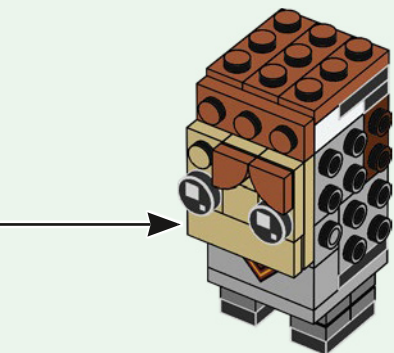

15

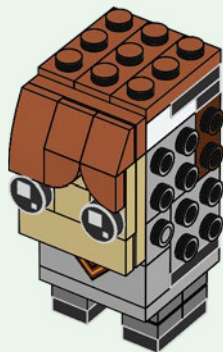

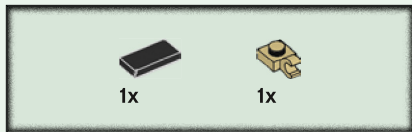

16

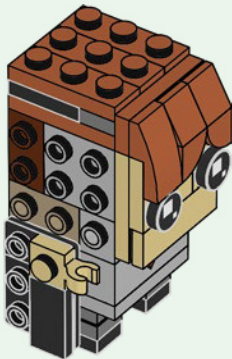



17

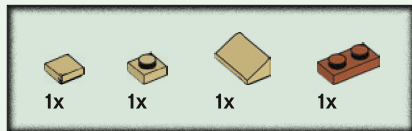
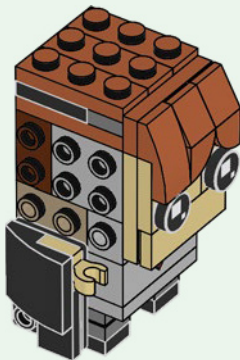

18

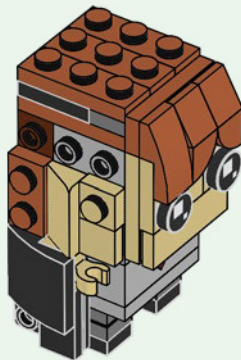



19

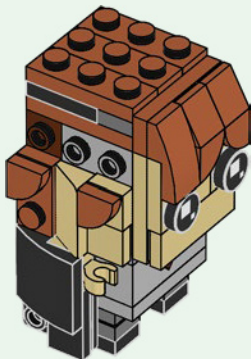

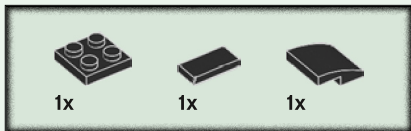

20

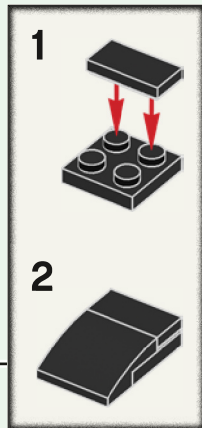
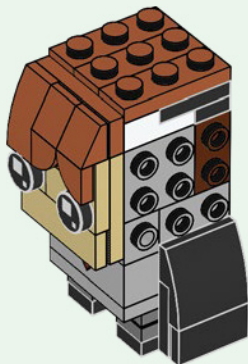

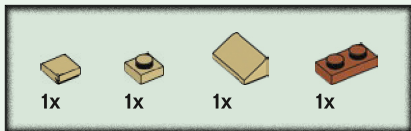

21

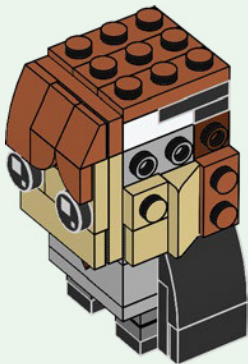



22

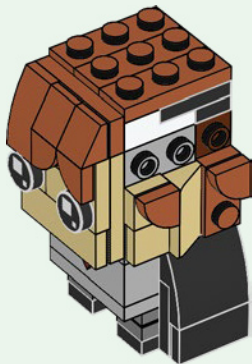

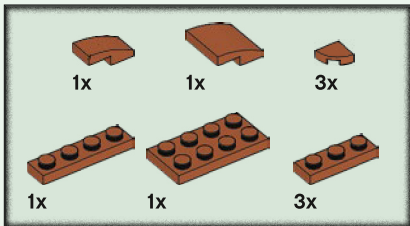

23

1

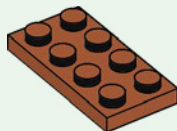

2

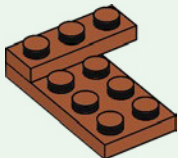

3

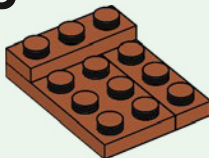

4

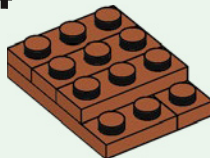

5

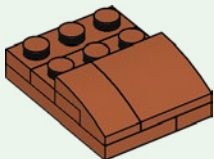

6

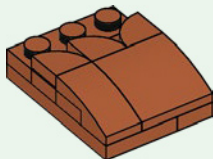

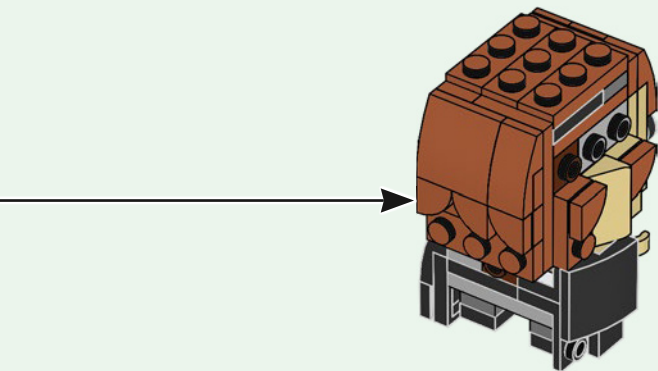

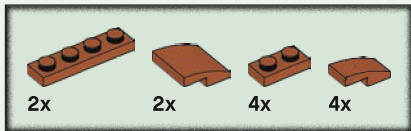

24

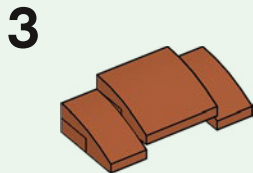
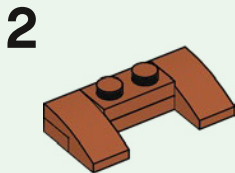
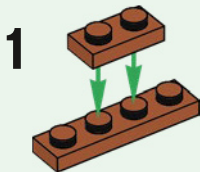

4

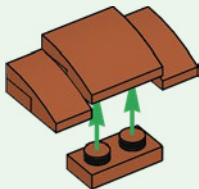

2x

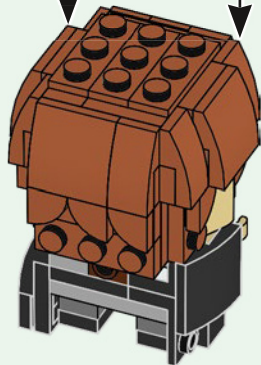

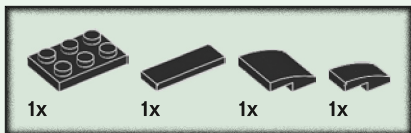

25

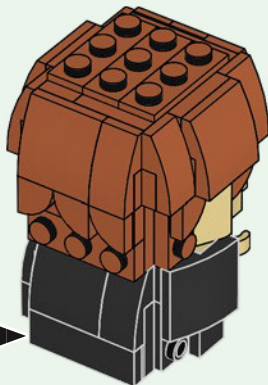
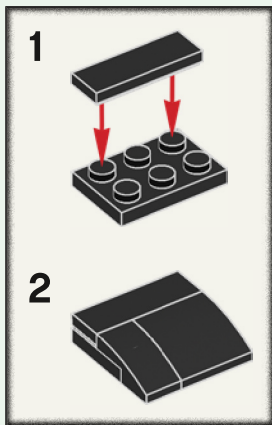

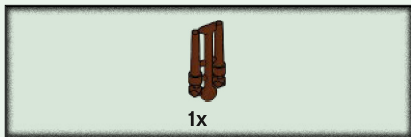

26

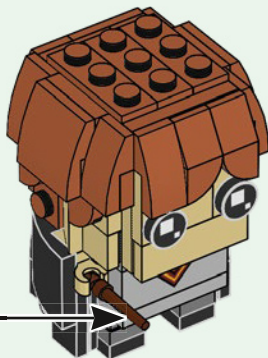

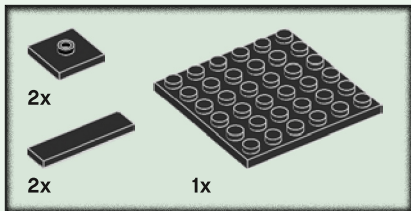

27

1

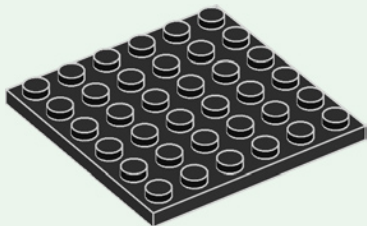

2

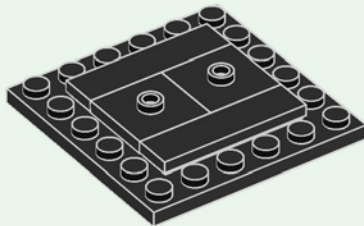

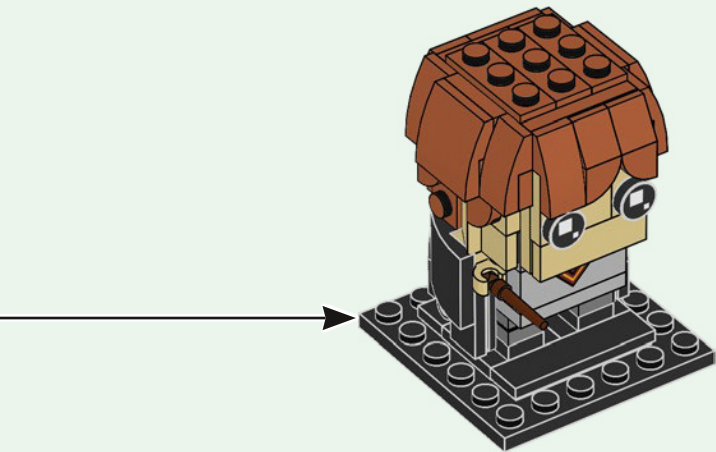



BRICK 'HEADZ



Harry Potter



LEGO and the LEGO logo are trademarks of the LEGO Group.
©2021 The LEGO Group. 6373338

WIZARDING WORLD characters, names and related indicia
are © & ™ Warner Bros. Entertainment Inc. WB SHIELD:
© & ™ WBEI. Publishing Rights © JKR. (s21)

HARRY
POTTER™

139

HERMIONE
GRANGER™

140

RON
WEASLEY™

141

HAGRID™

142