

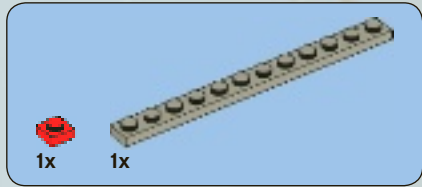

8486

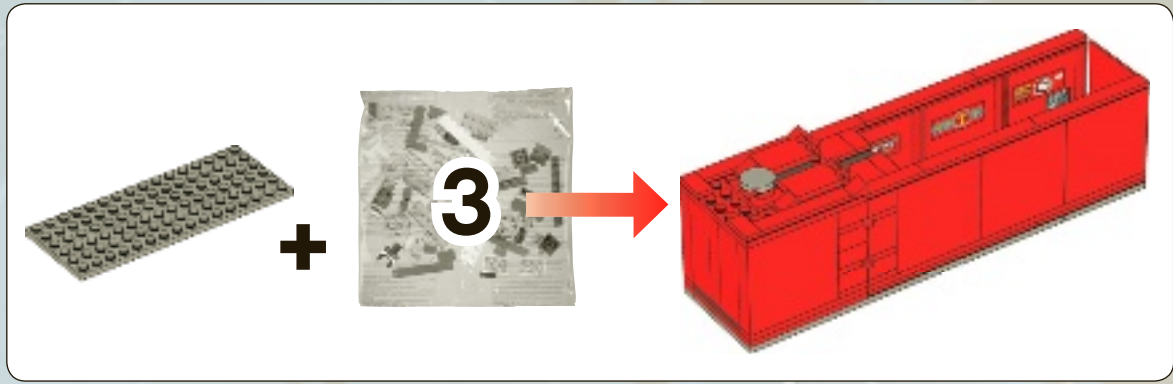



1

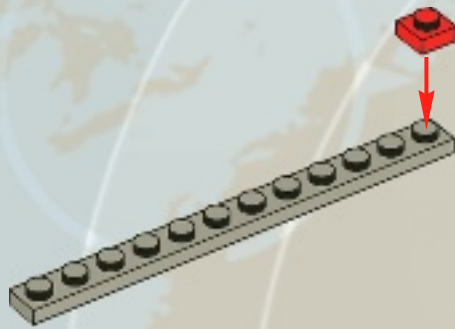

2

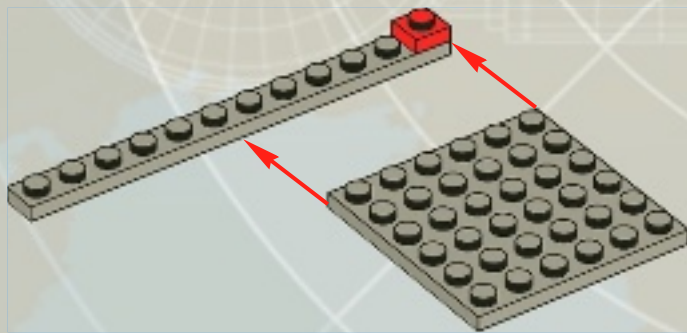

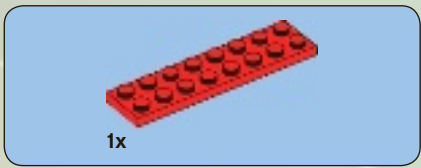

3

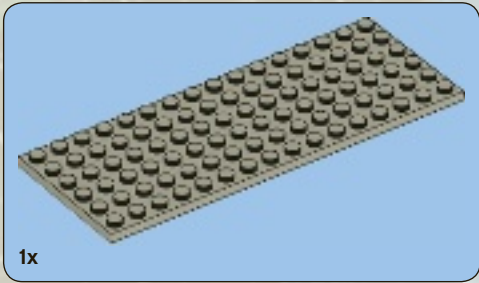

4

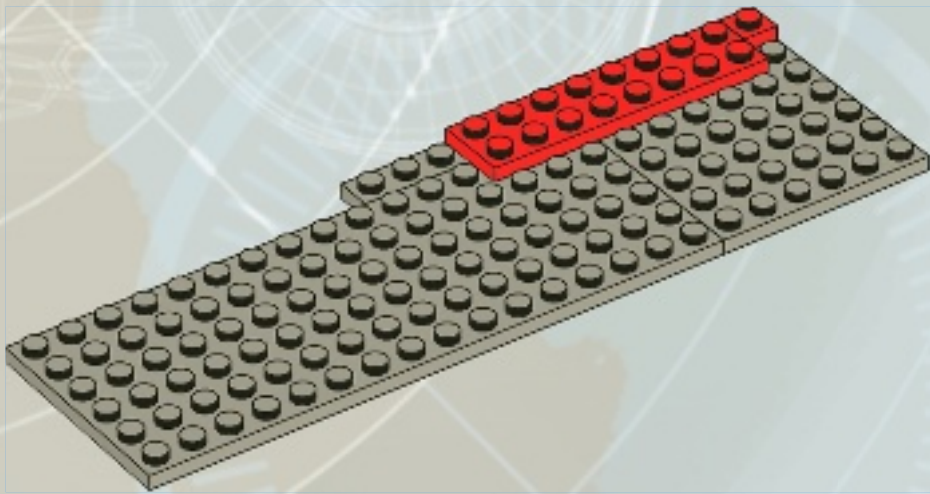

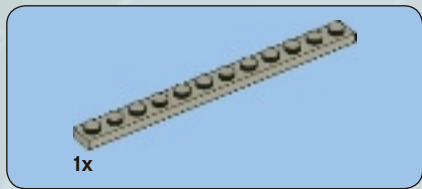

5

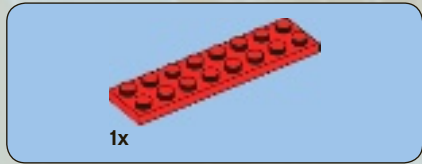
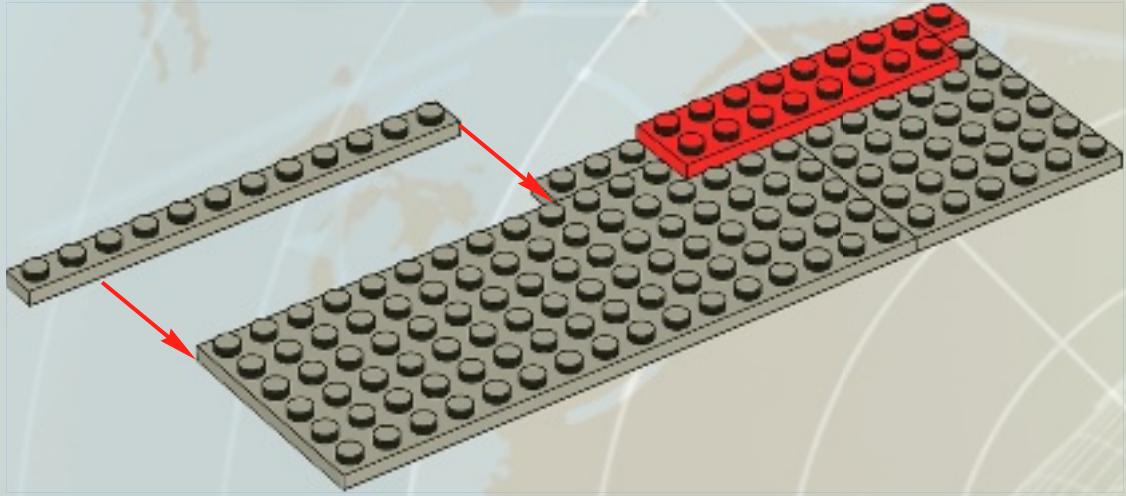

6

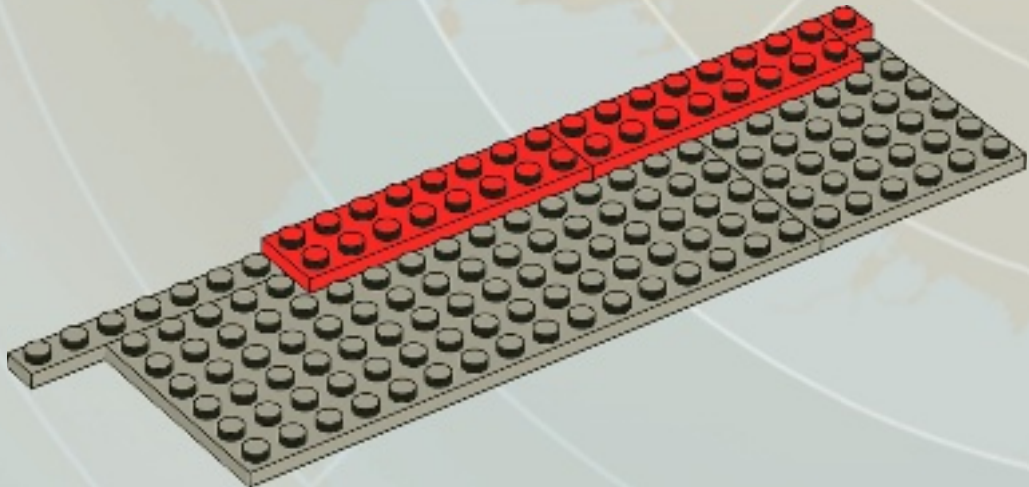

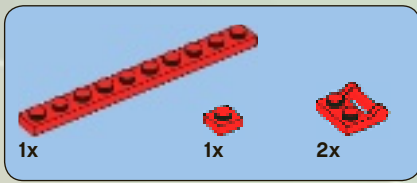

7

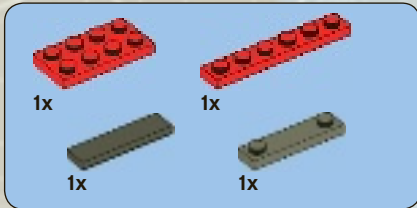
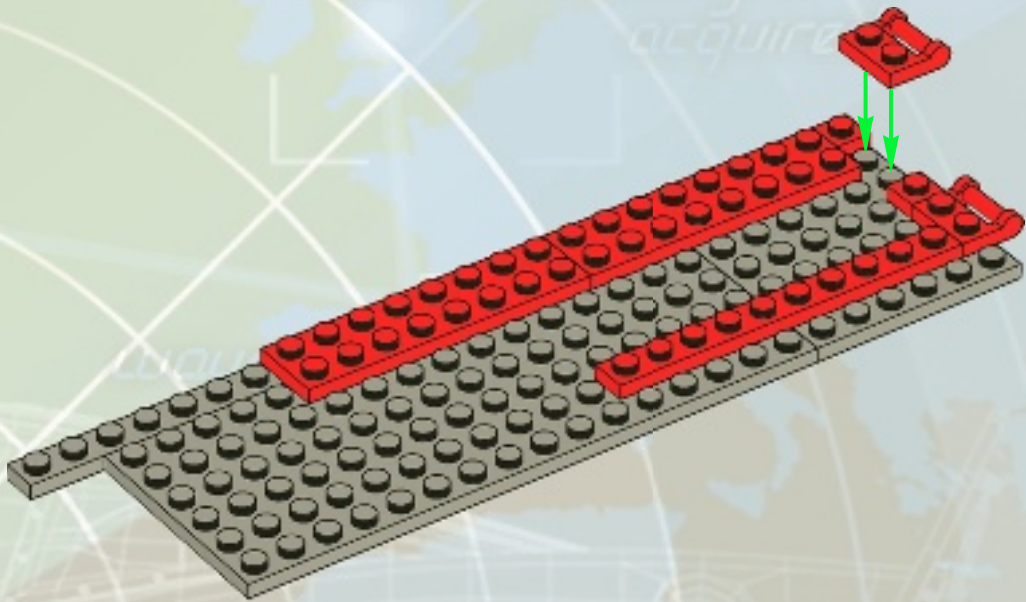

8

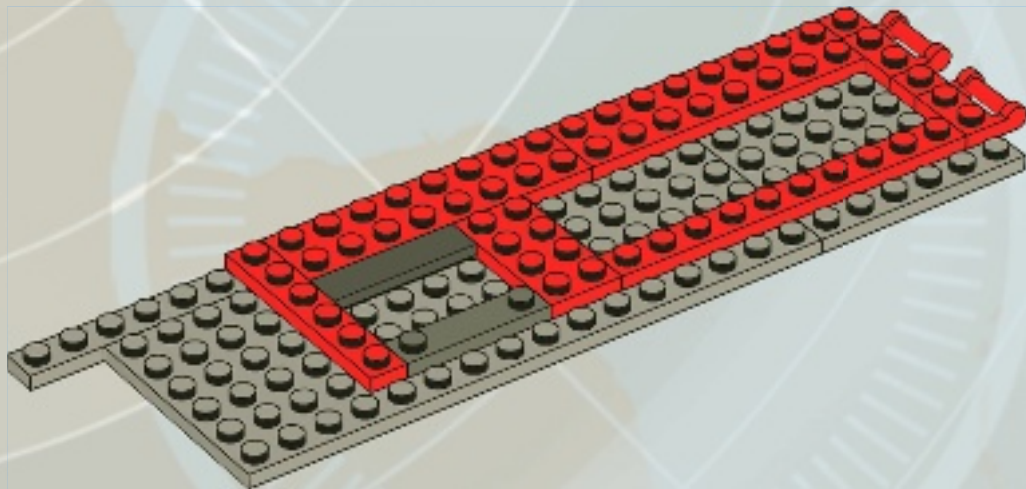

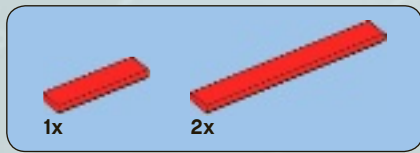

9

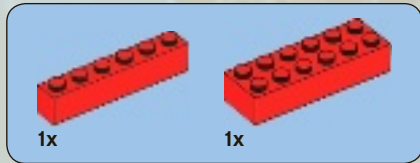
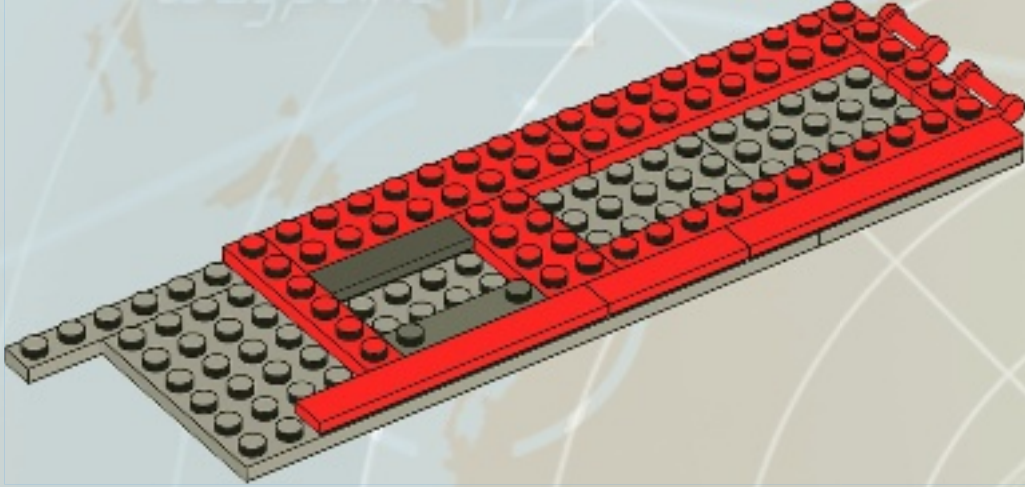

10

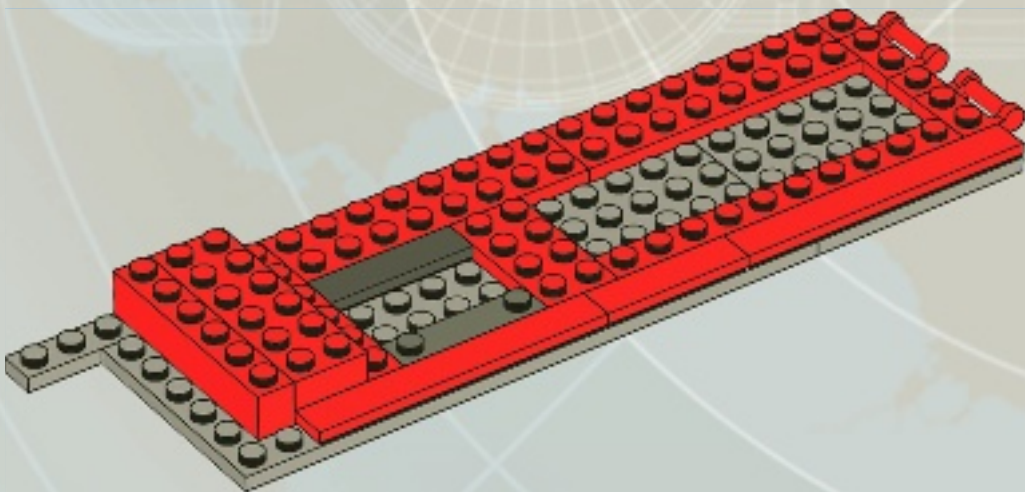

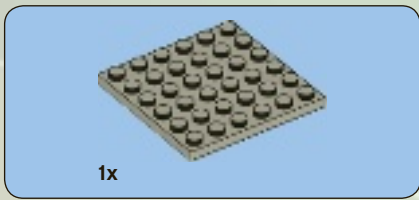

11

target
acquired

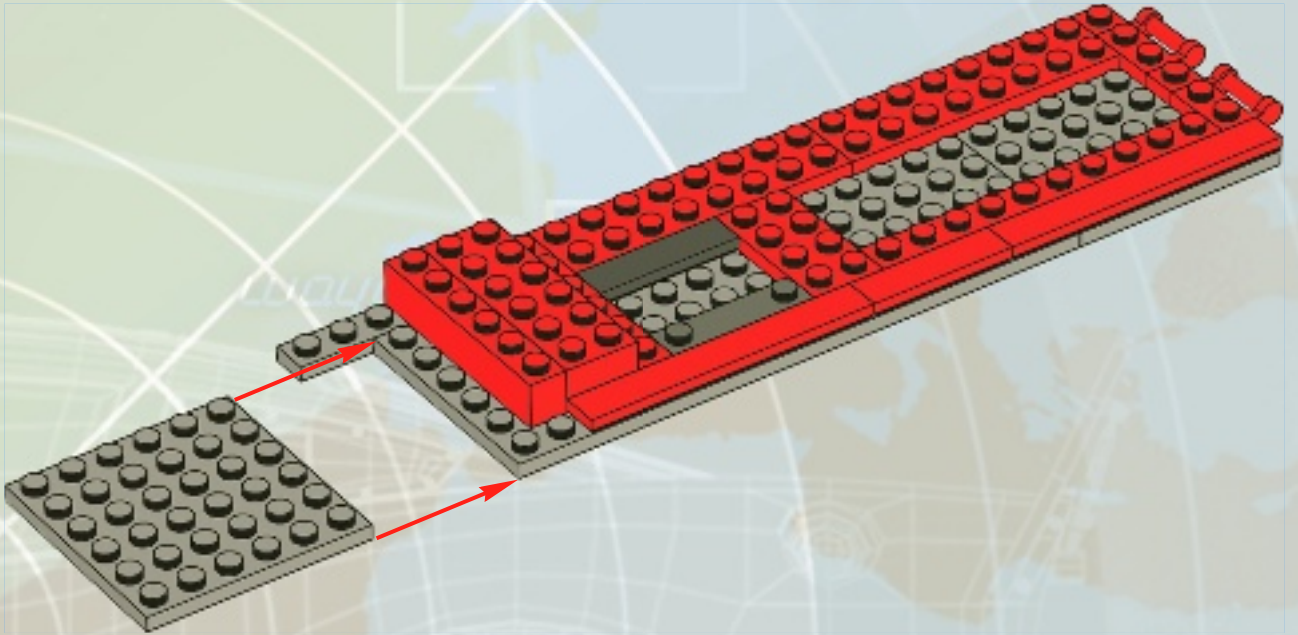

12

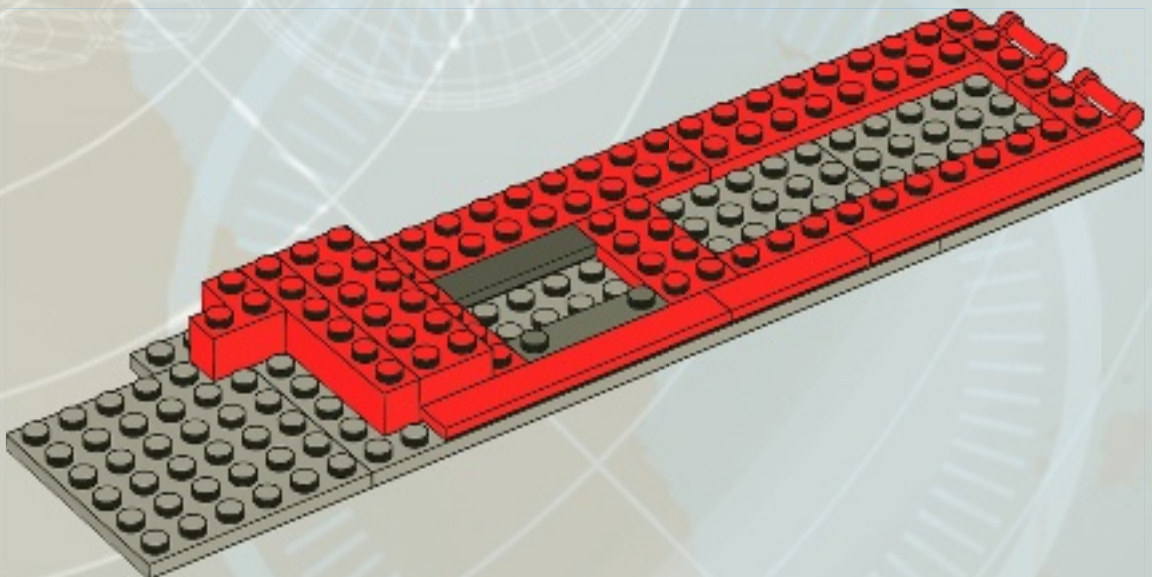

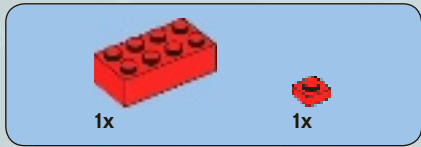

13

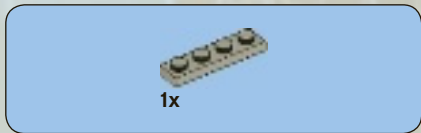
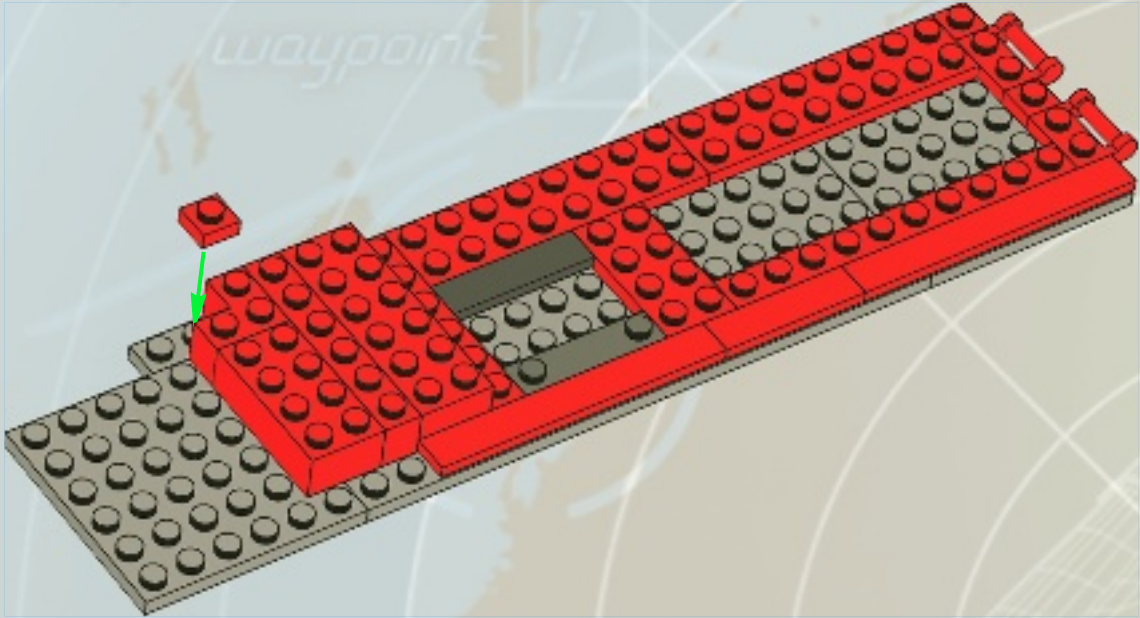

14

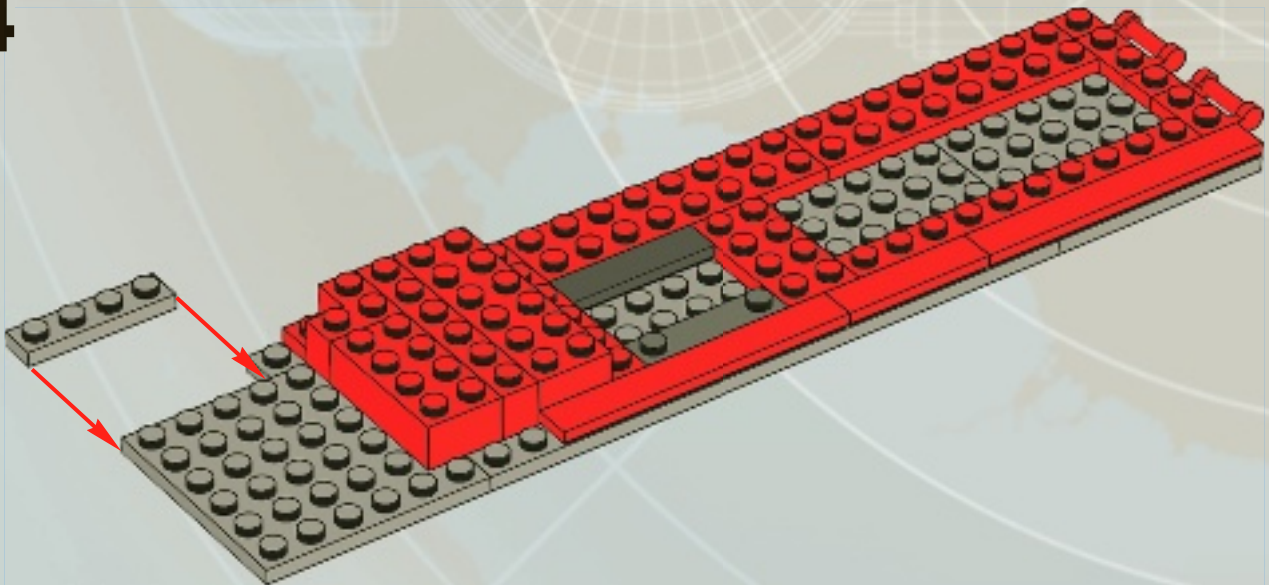

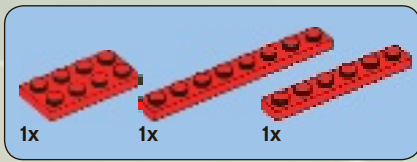

15

target
acquired

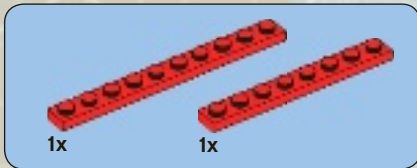
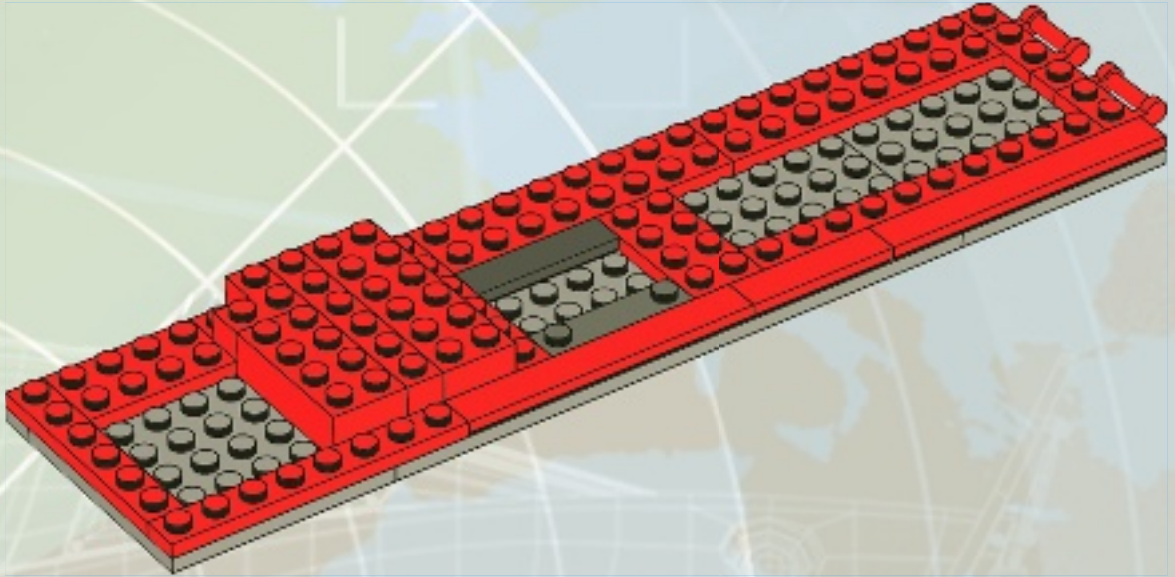

16

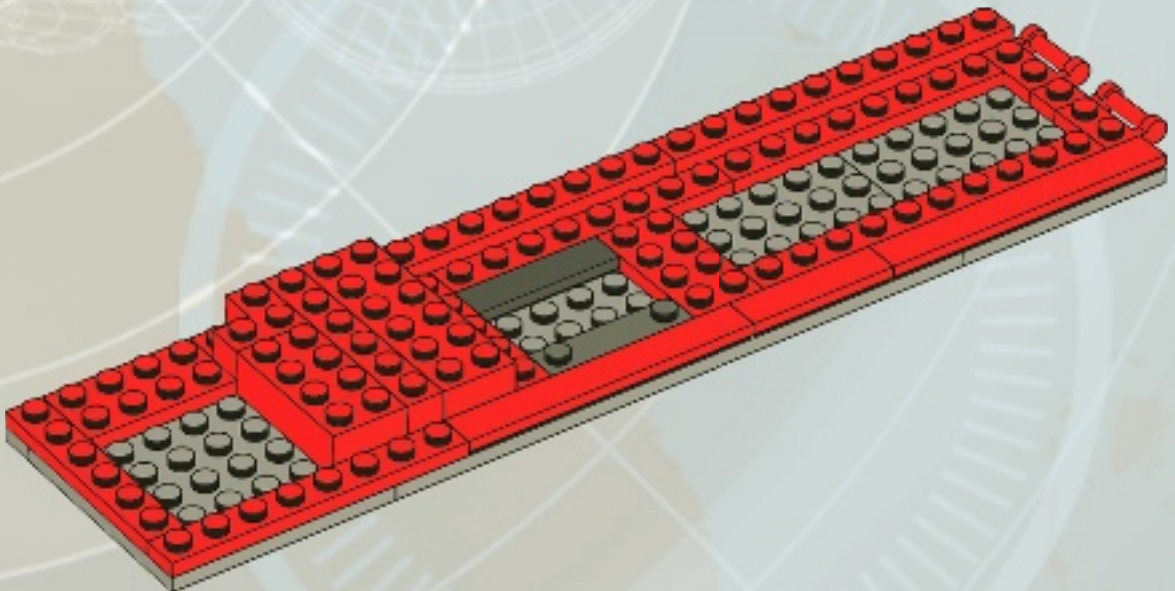

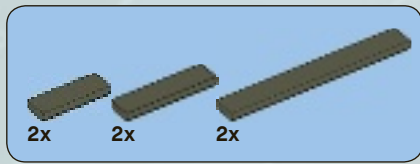

17

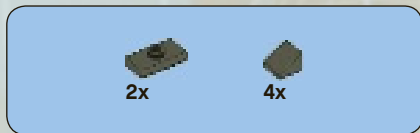
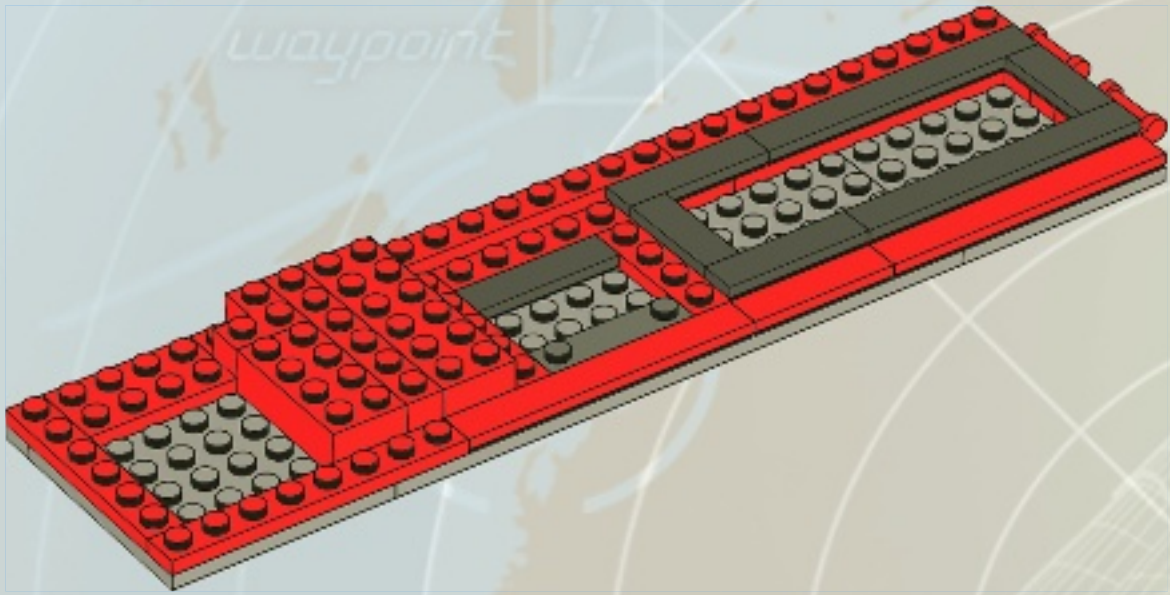

18

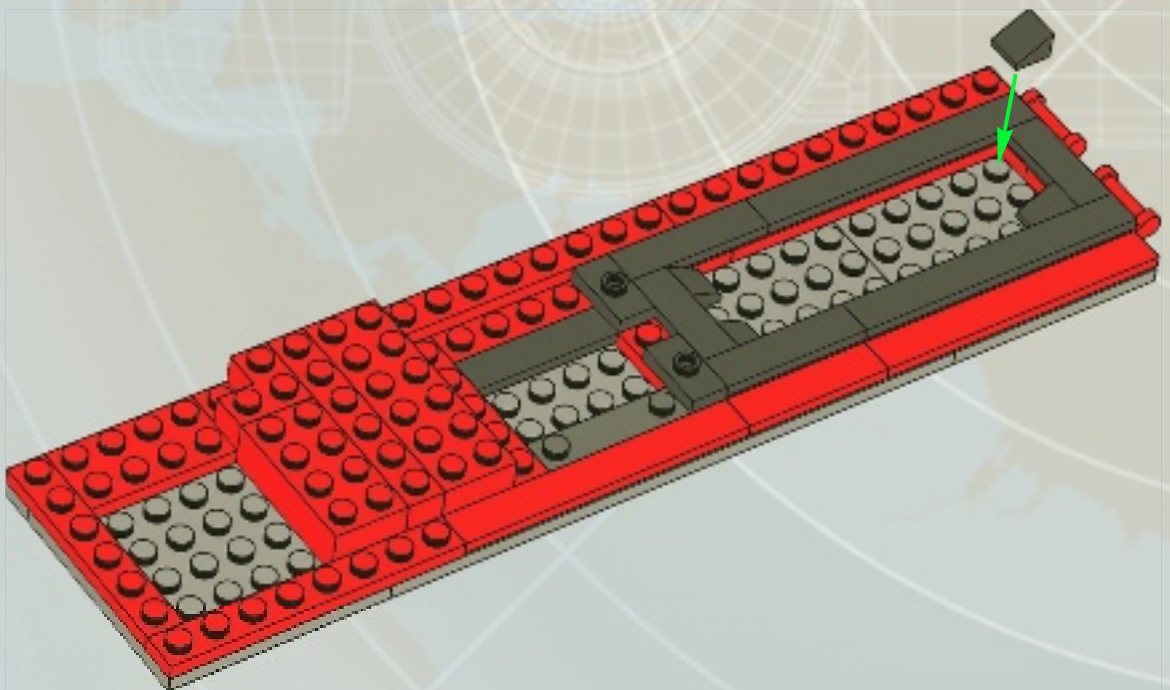

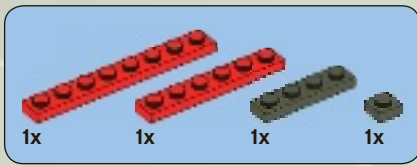

19

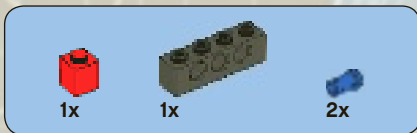
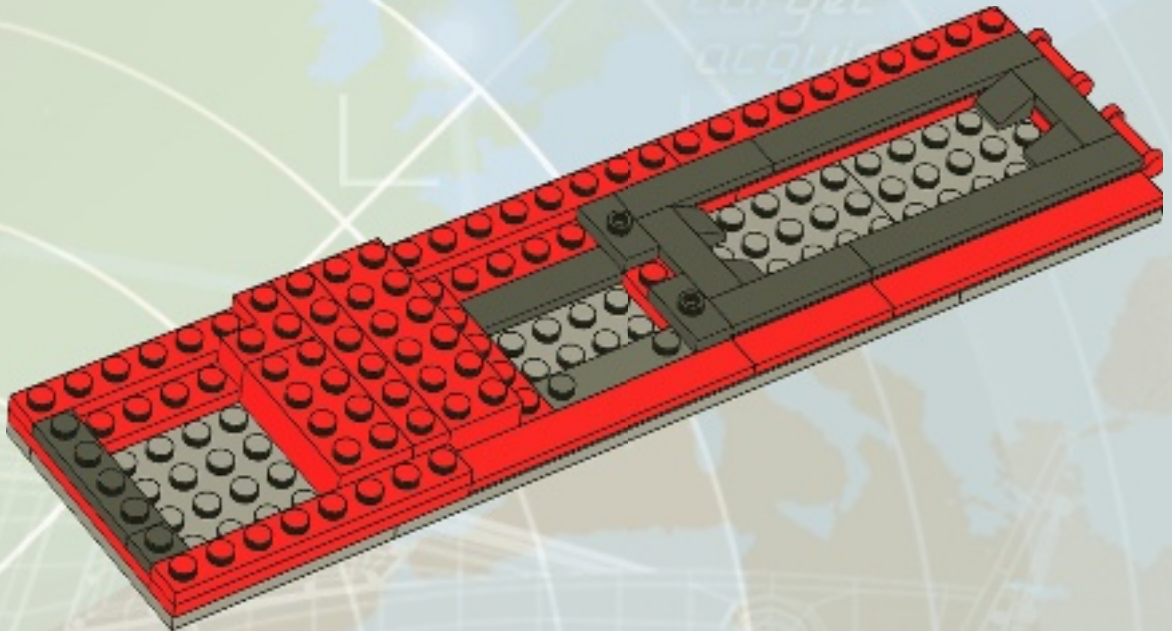

20

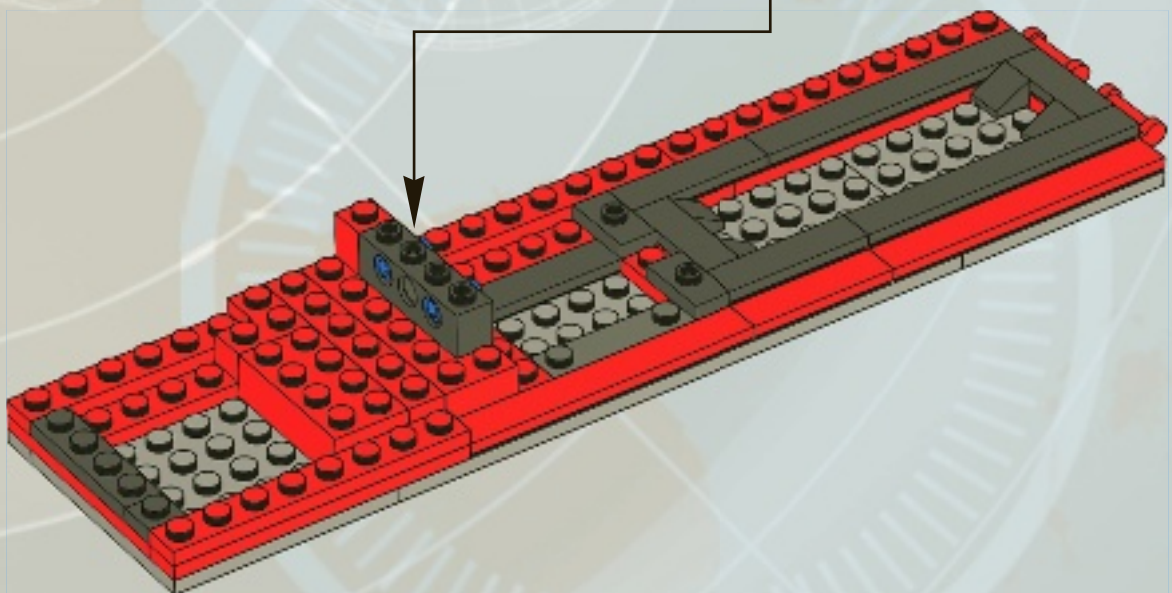
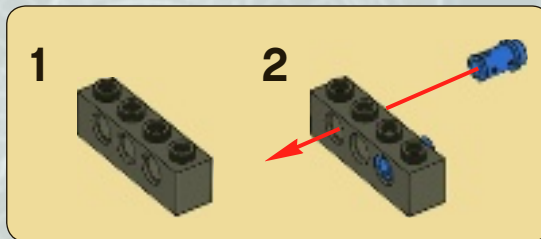

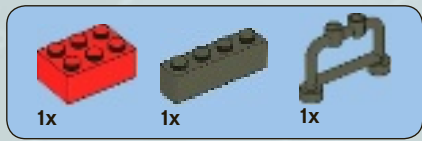

21

waypoint 1

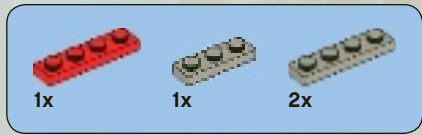
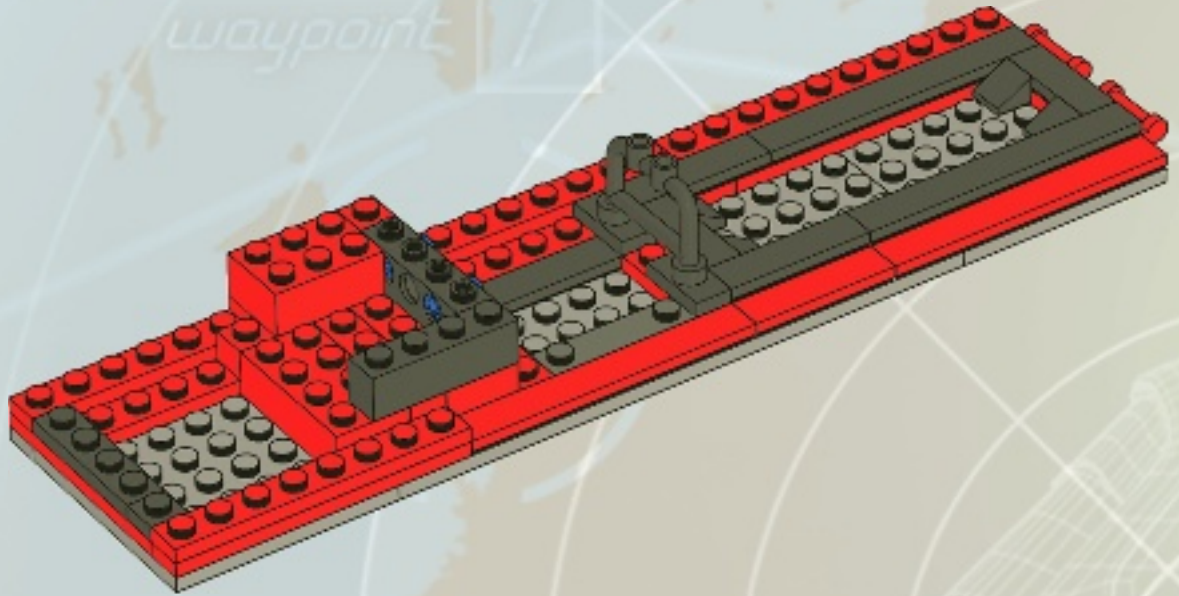

22

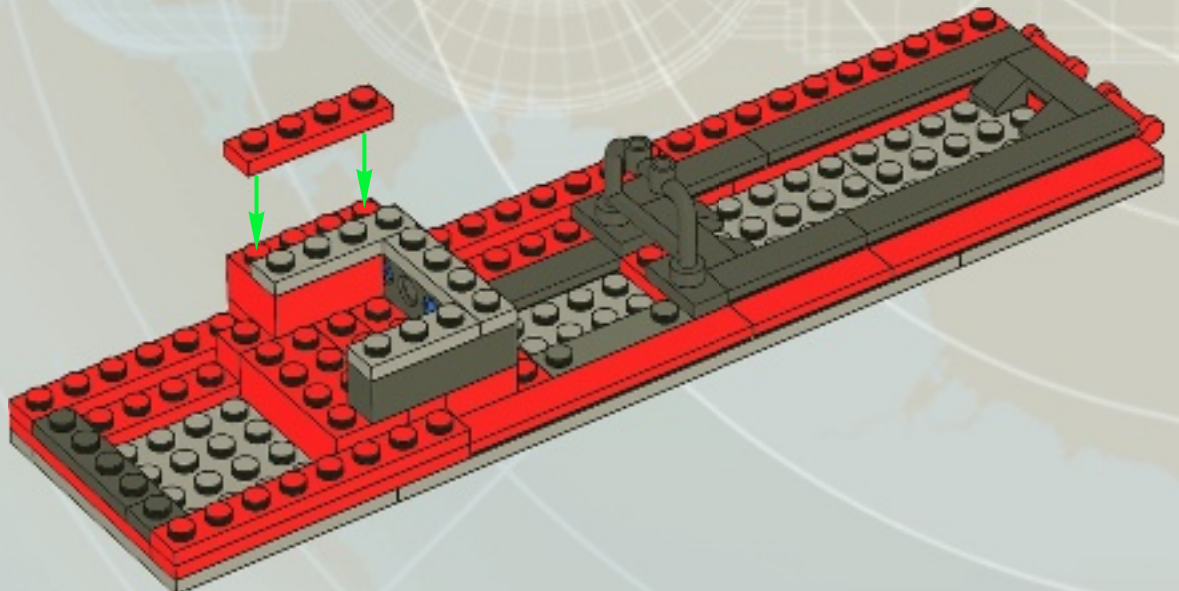



1x



1x

23

target
acquired

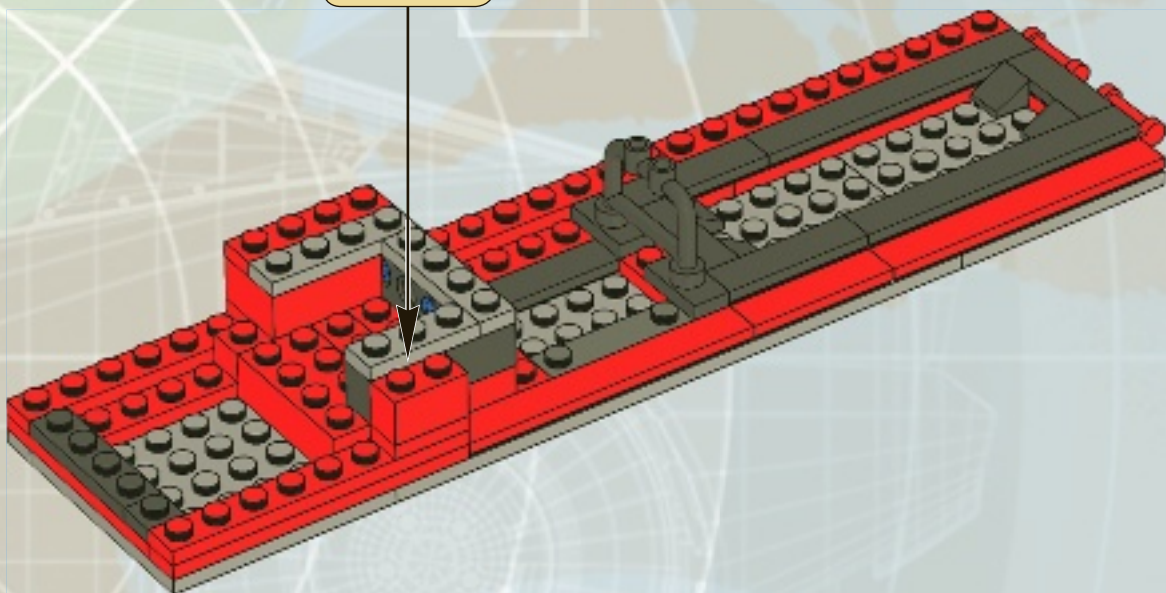
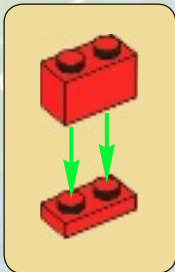

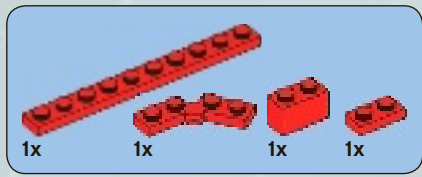

24

waypoint 1

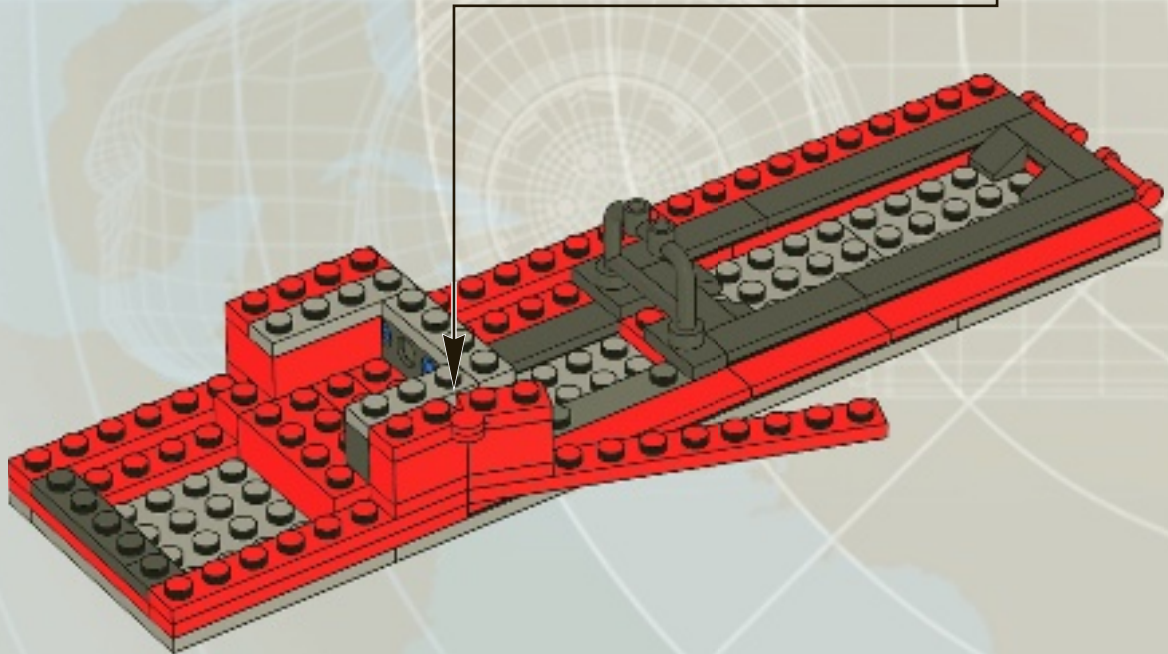
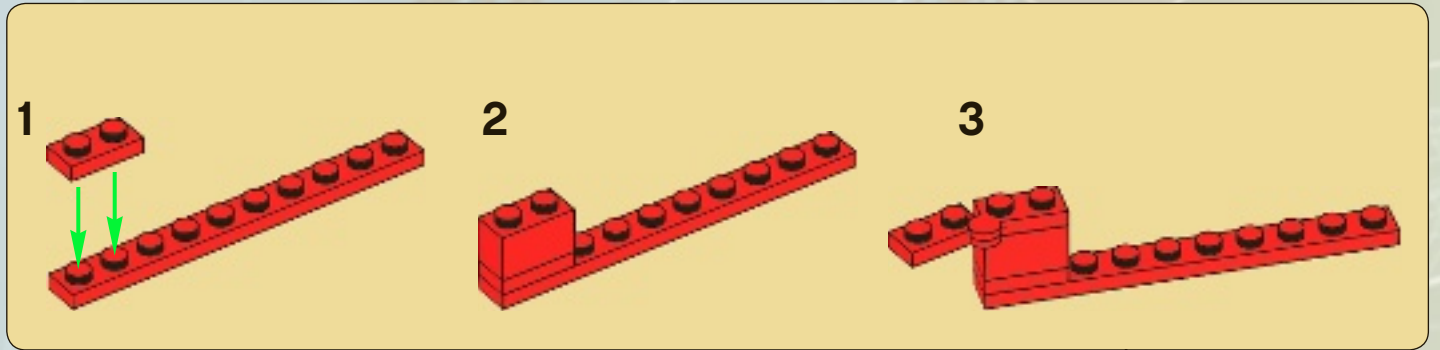

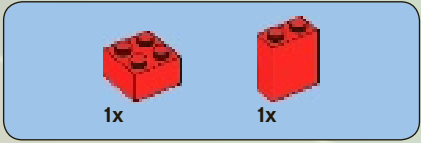

25

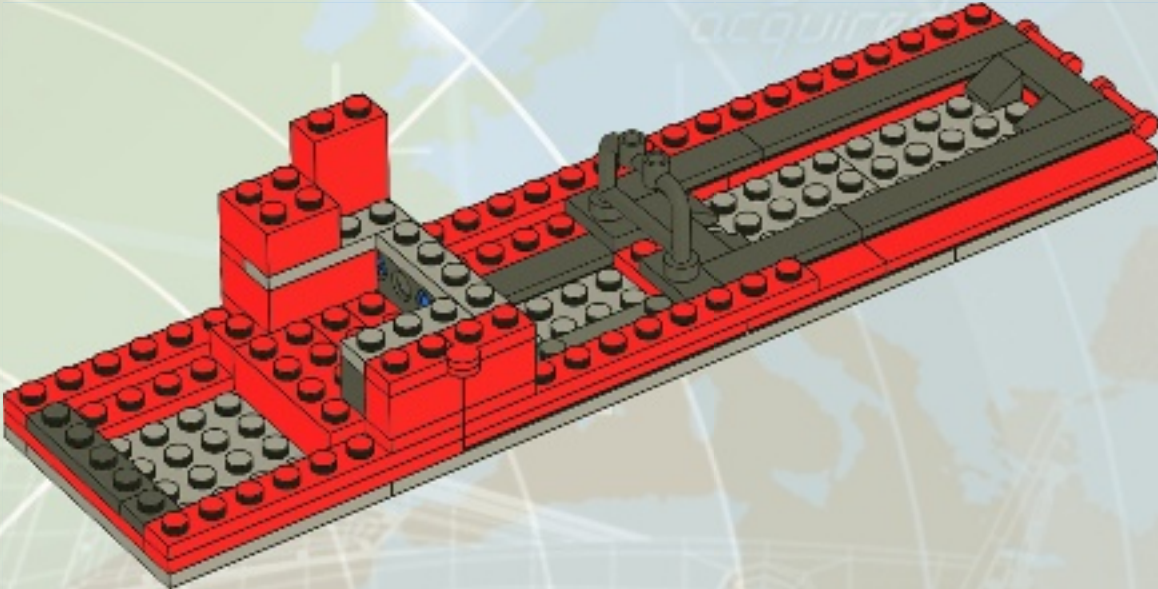

26

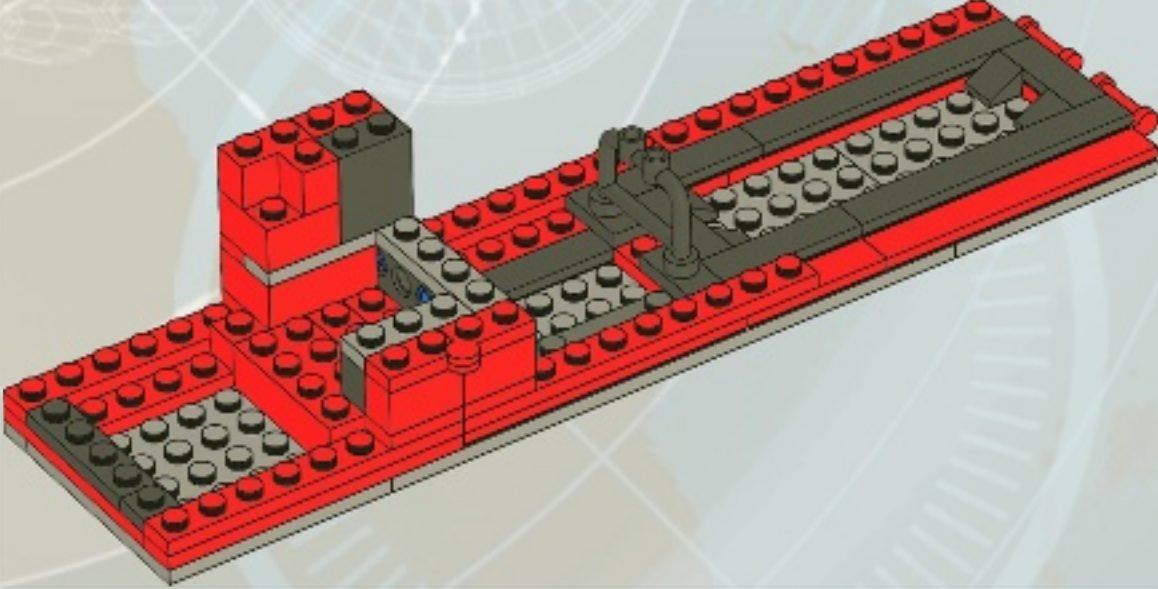



27

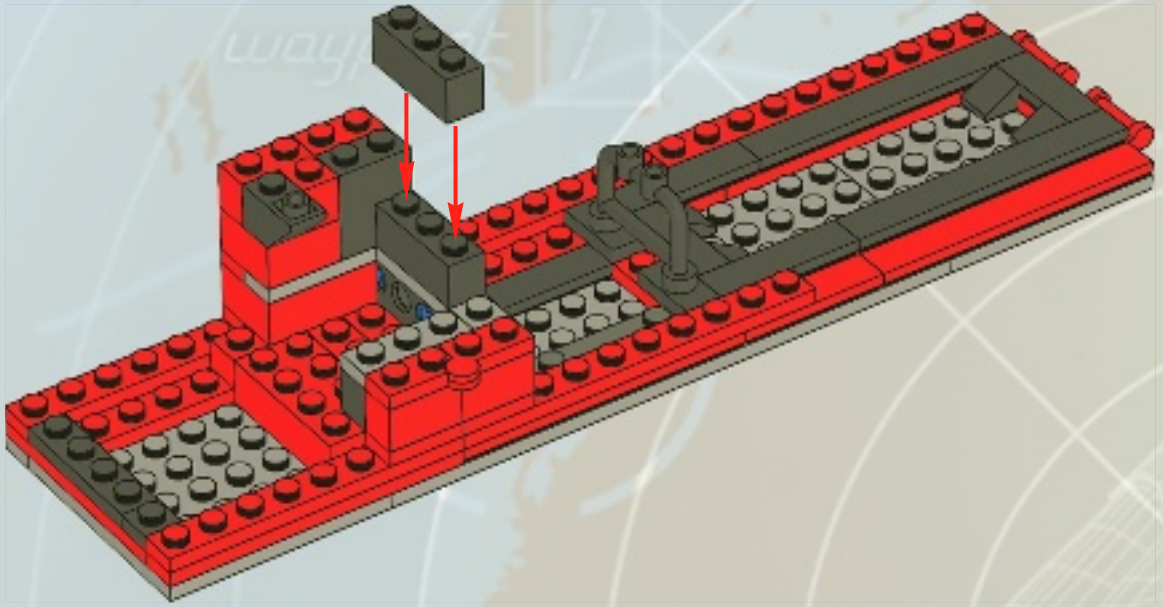

28

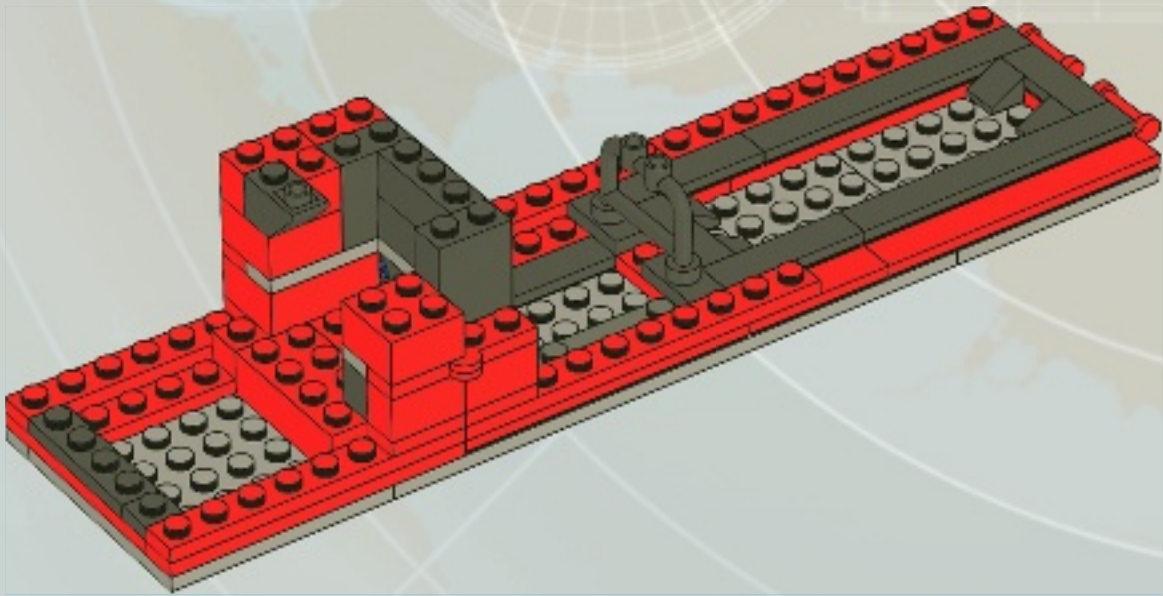

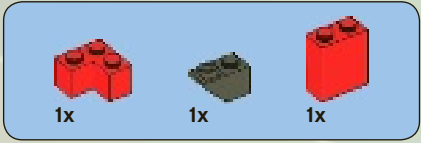

29

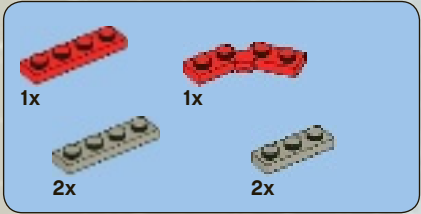
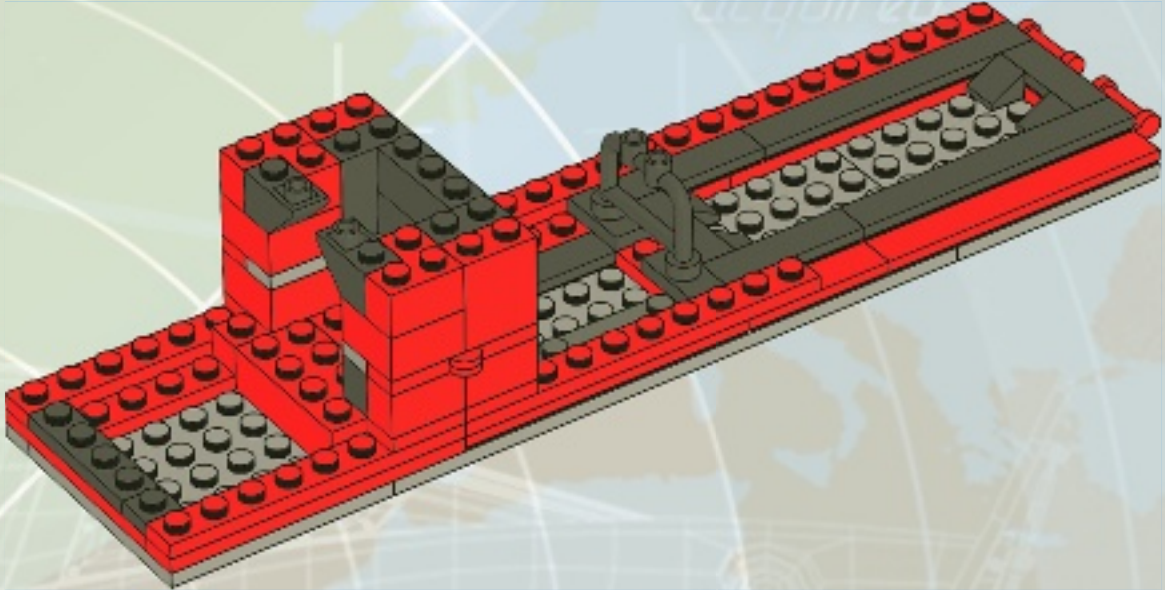

30

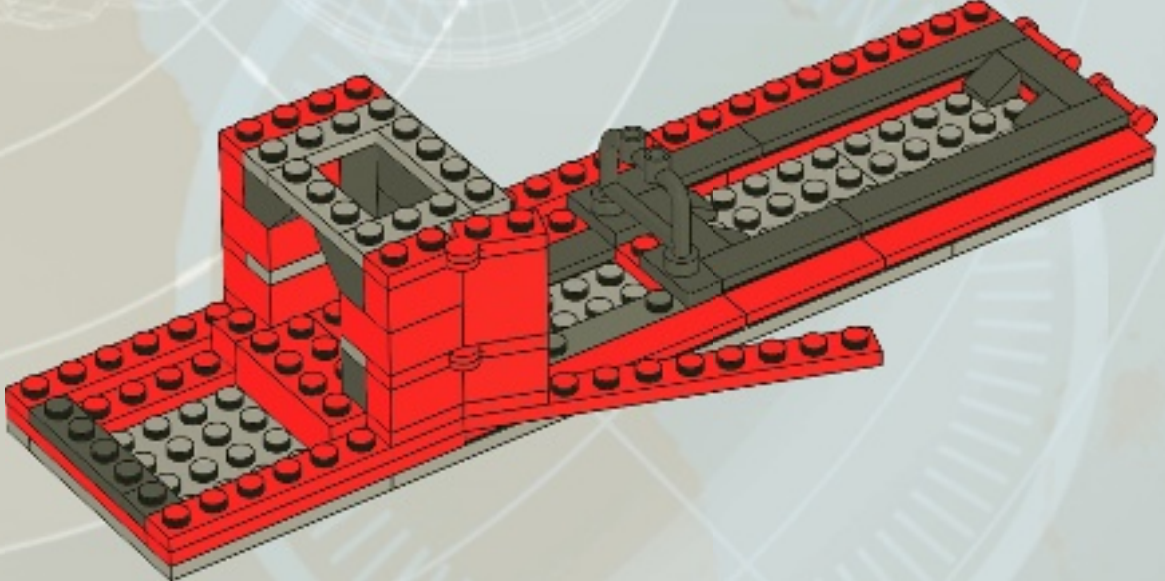

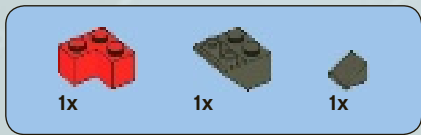

31

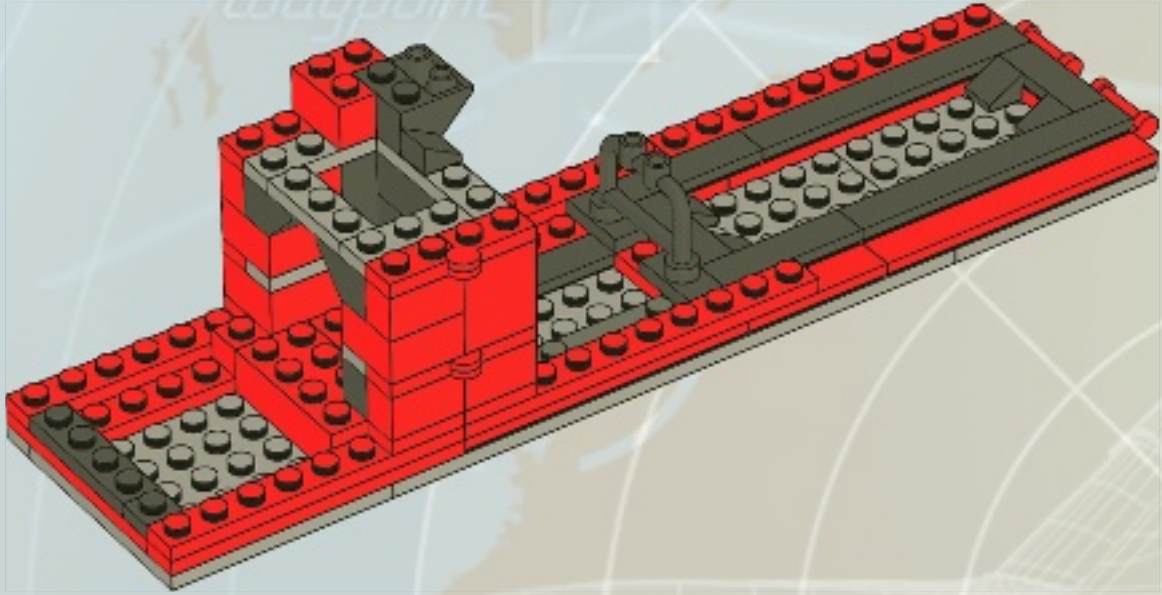

32

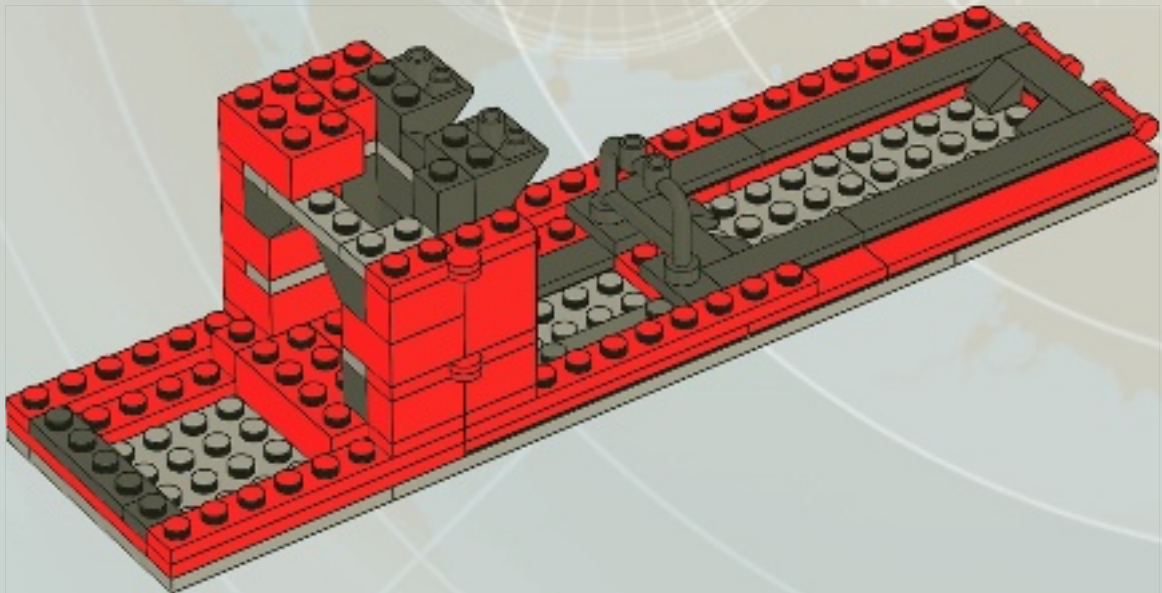

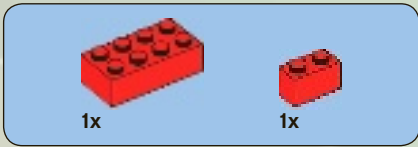

33

*target
acquired*

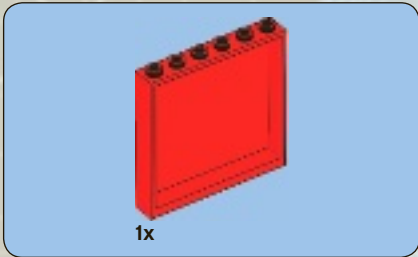
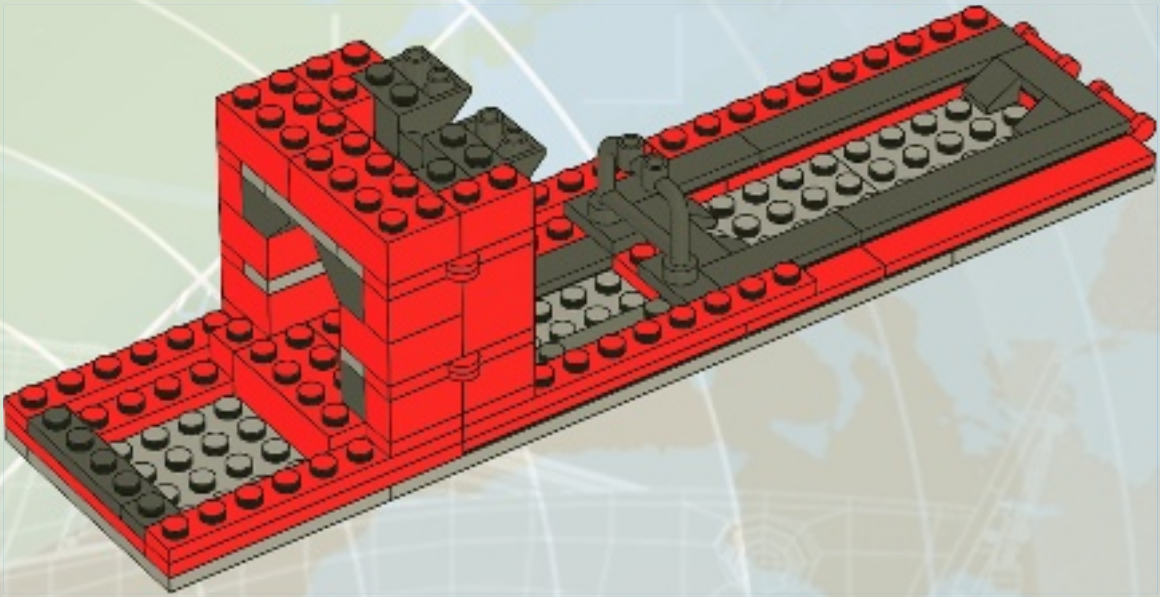

34

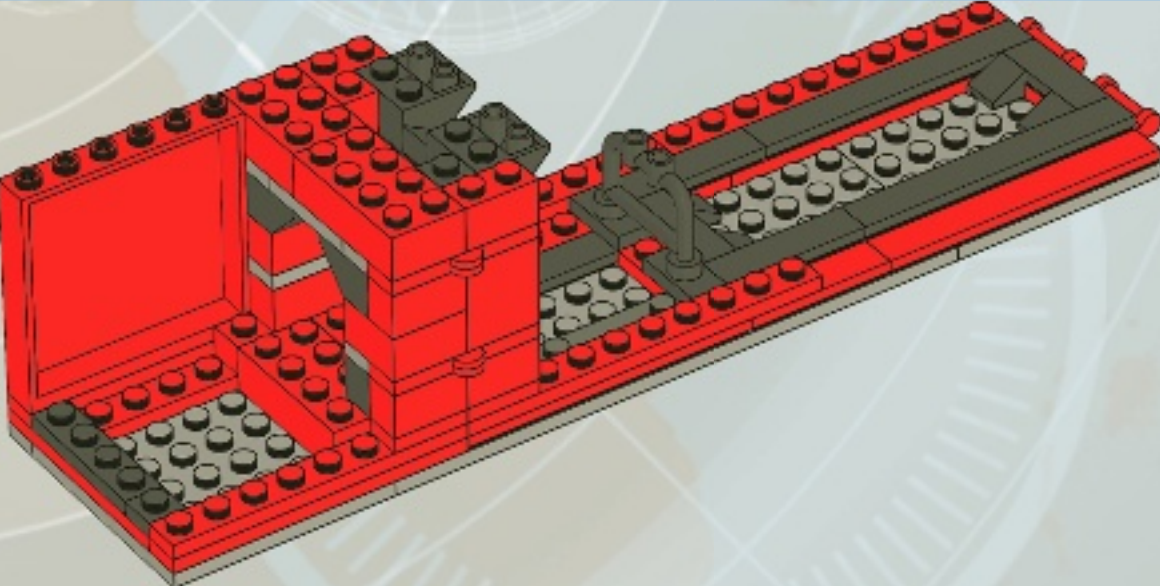

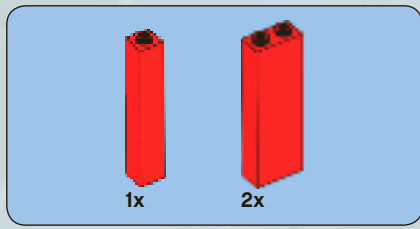

35

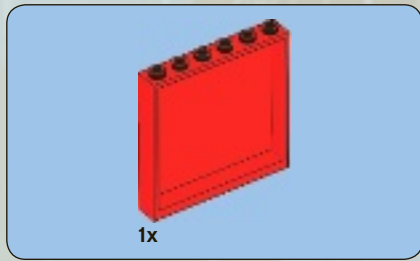
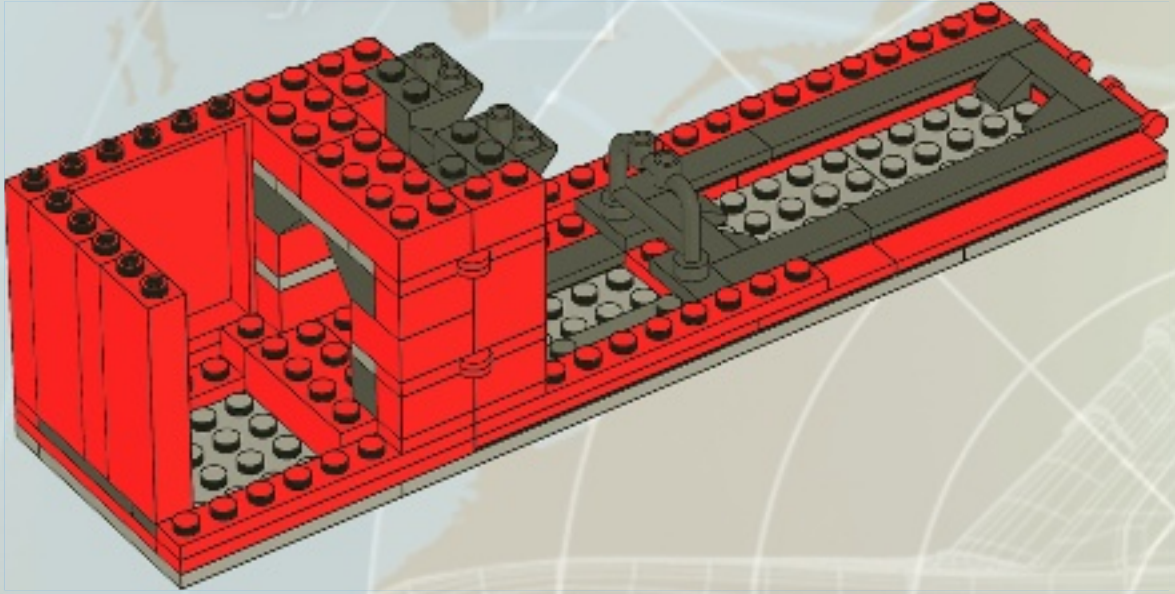

36

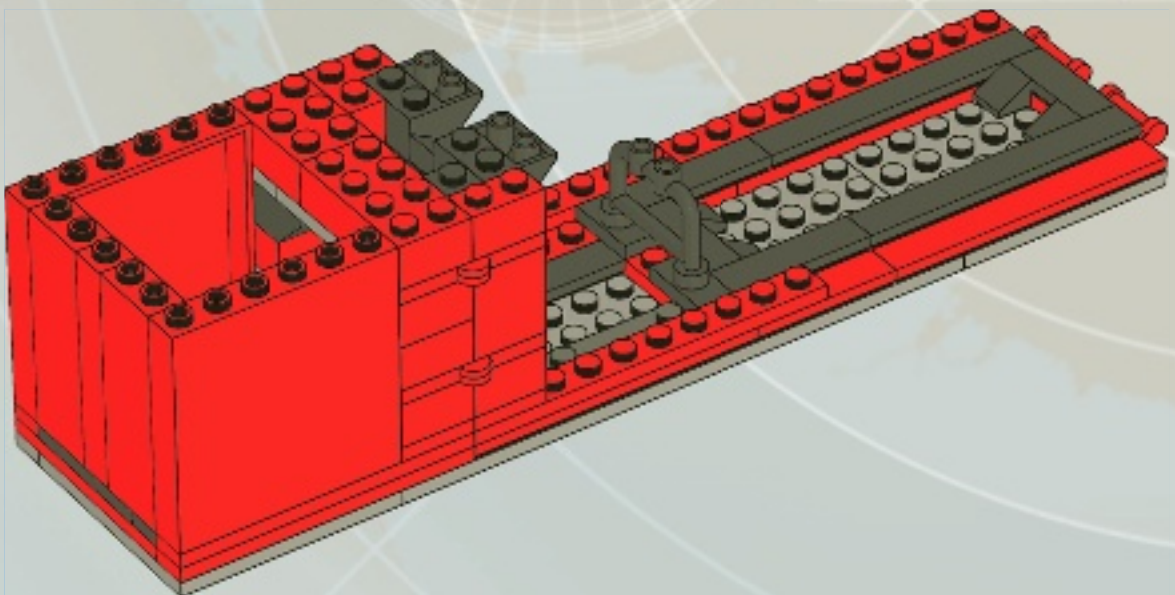

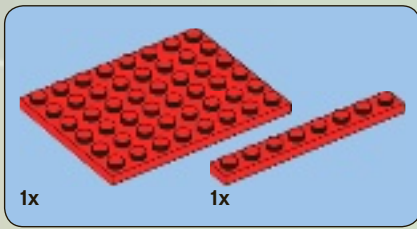

37

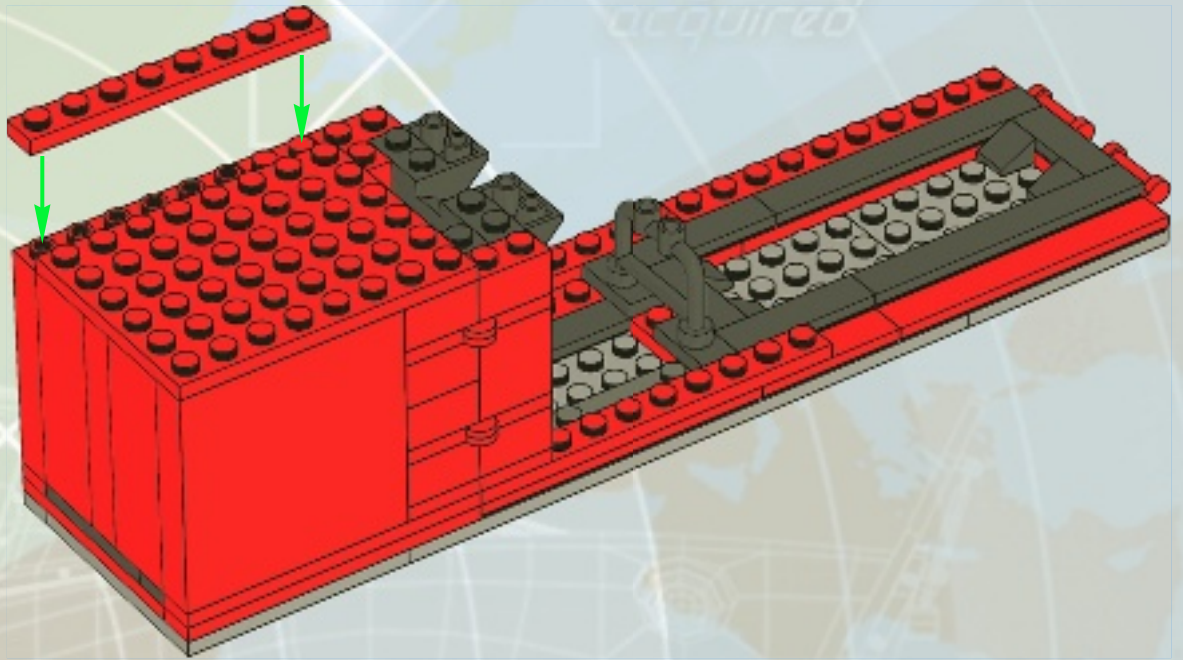

38

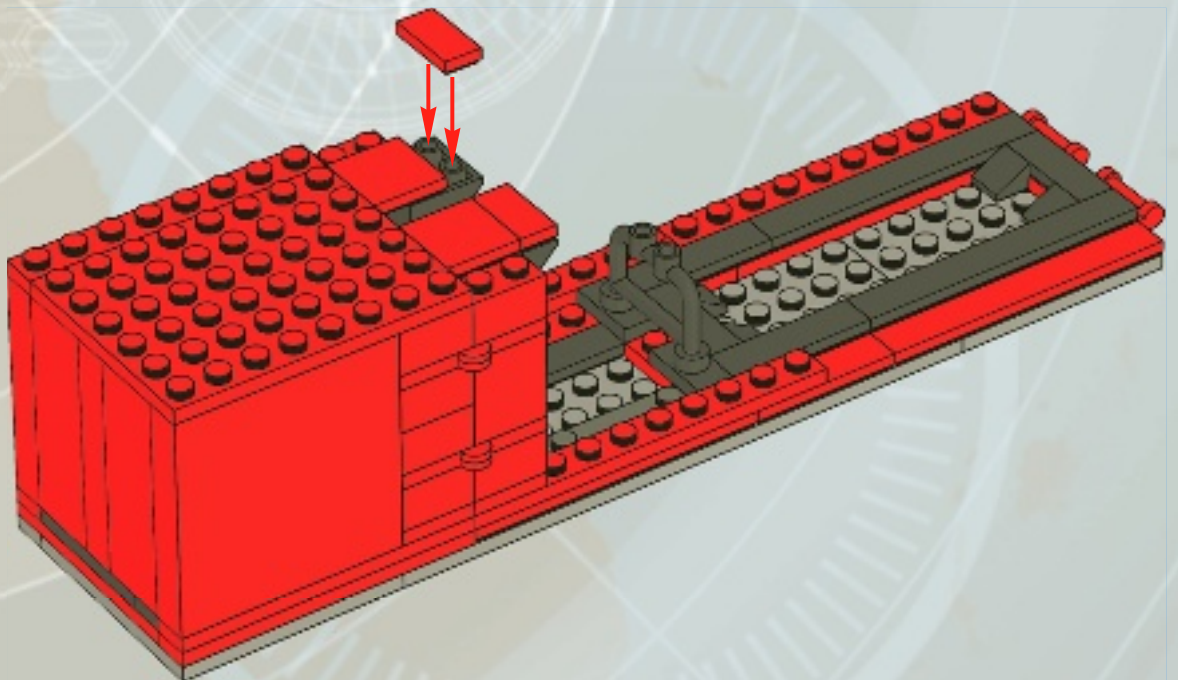

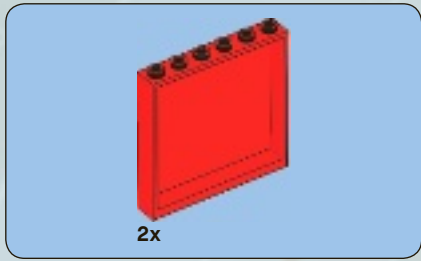

39

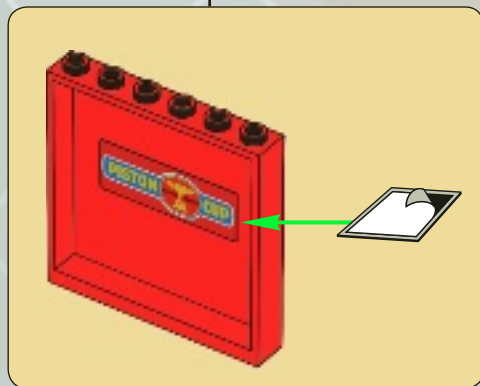
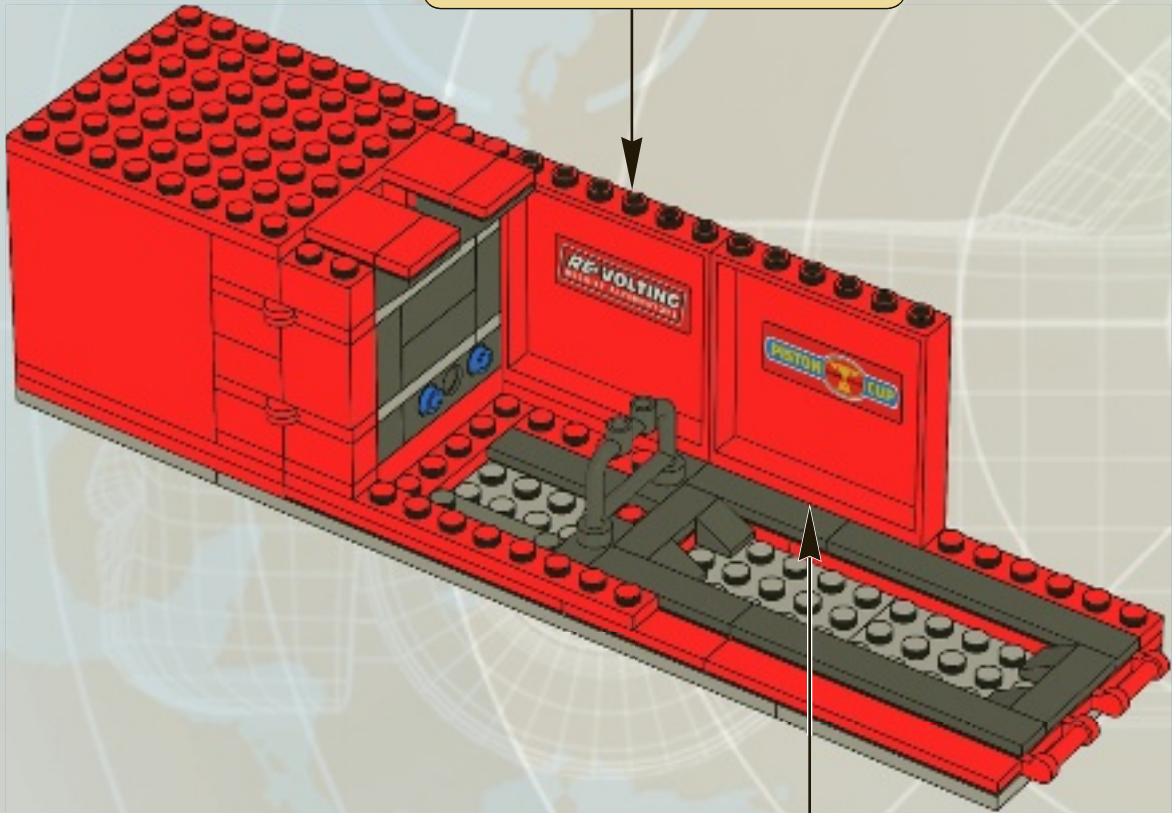
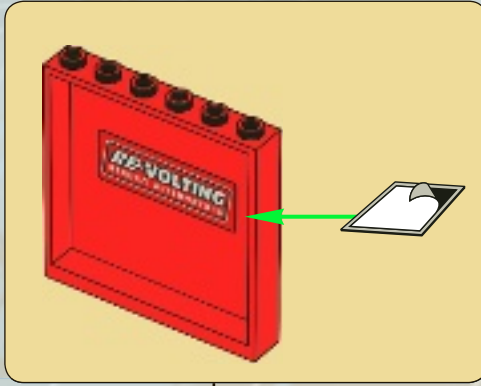

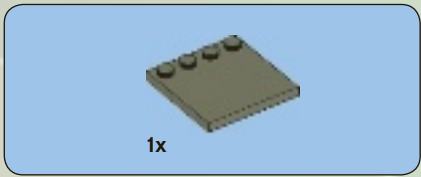

40

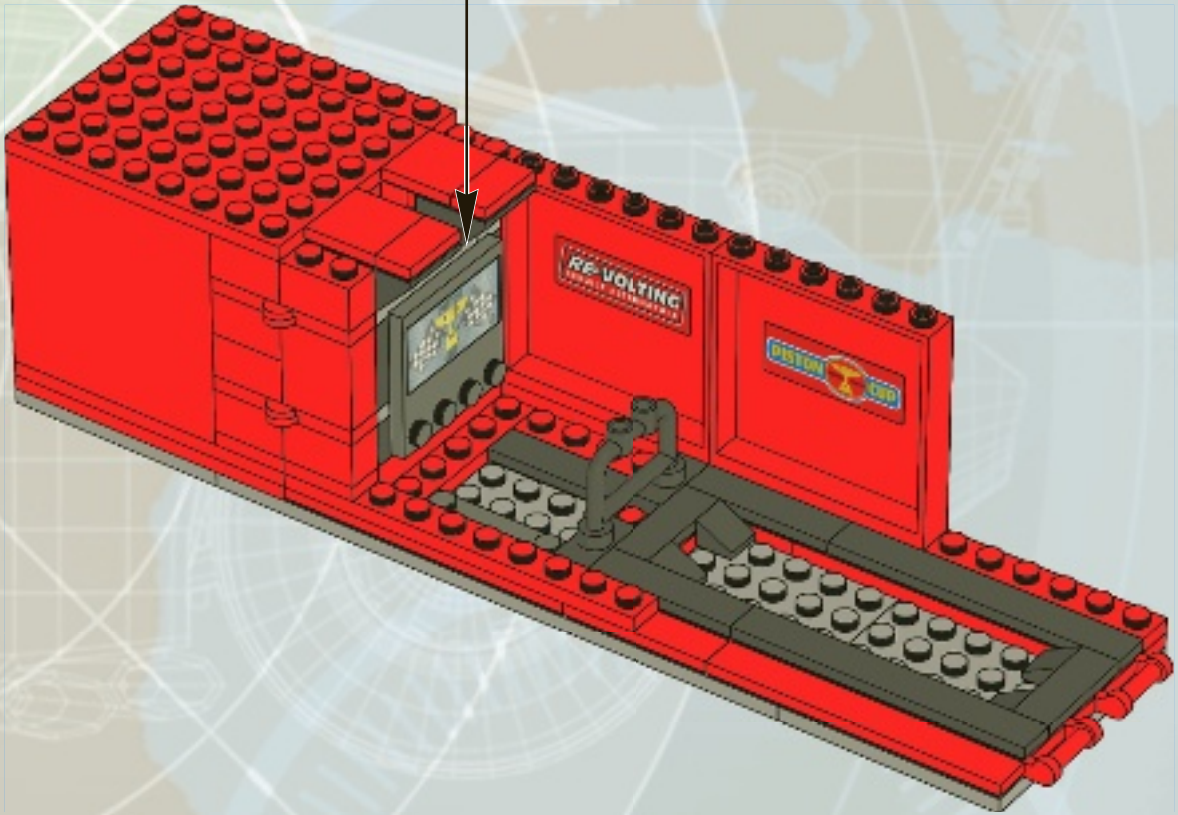
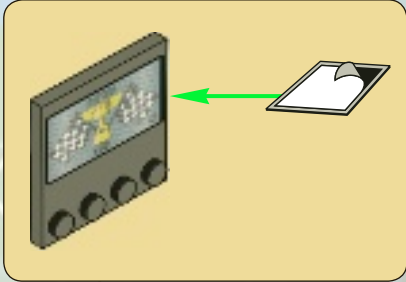

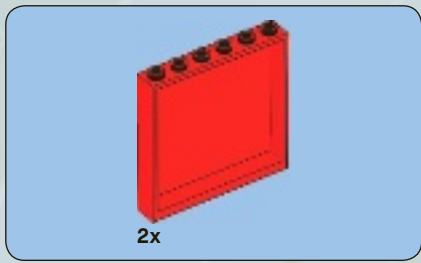

41

waypoint 1

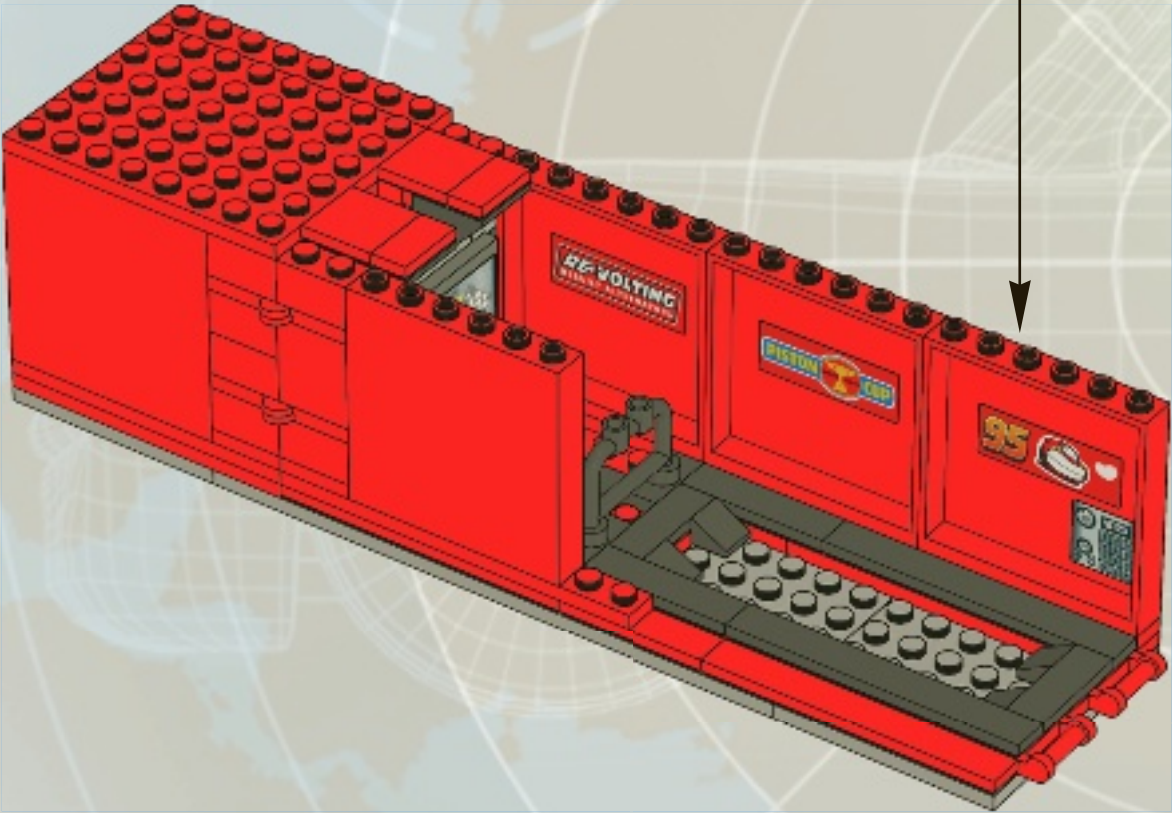
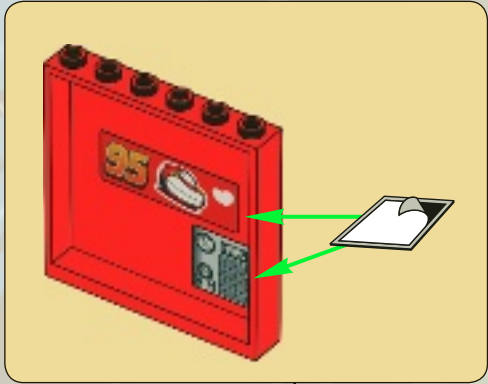

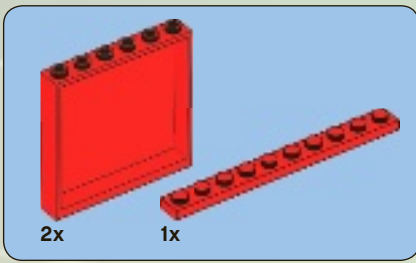

42

target
acquired

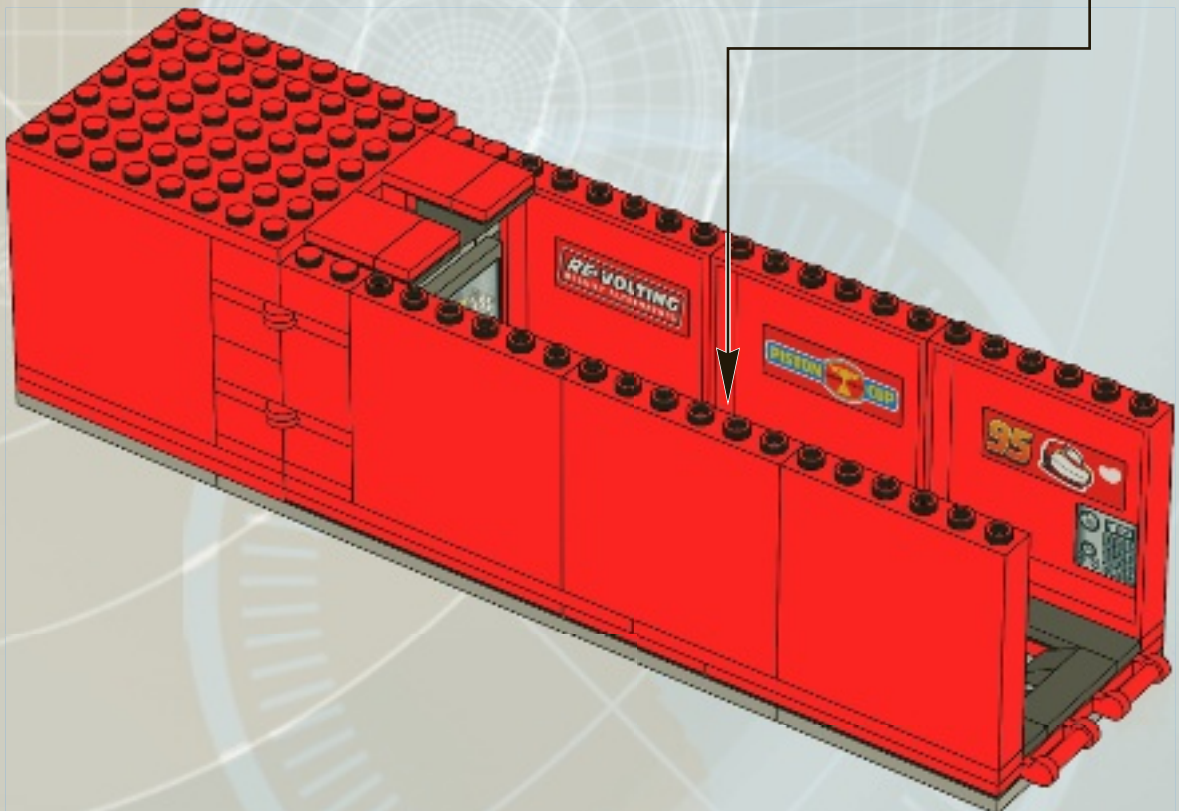
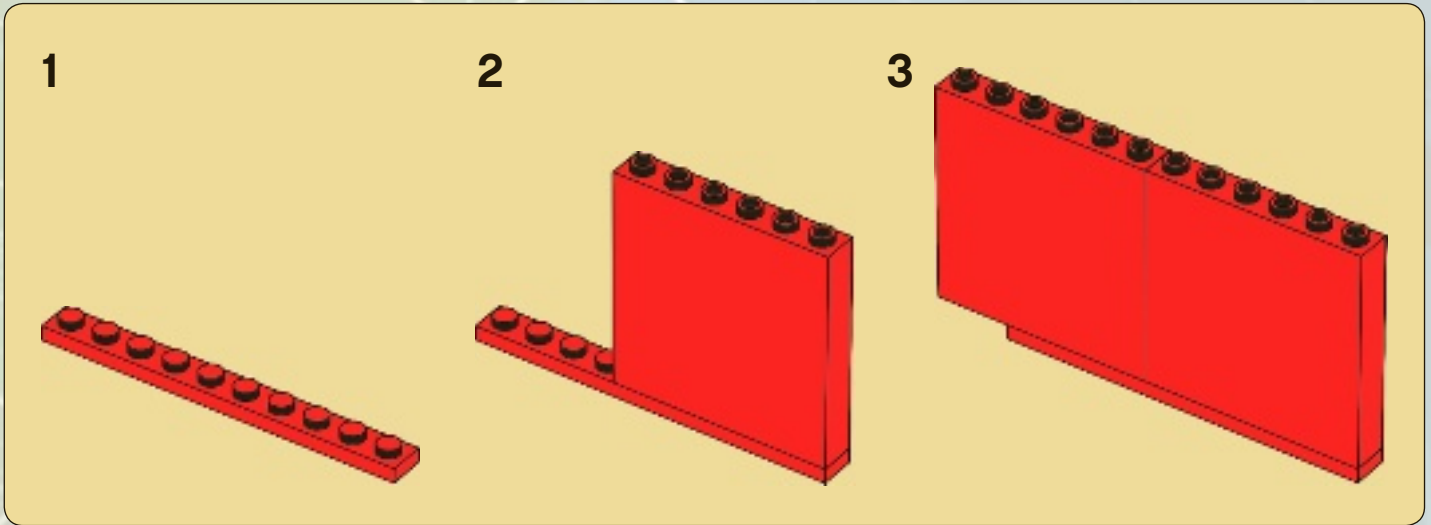

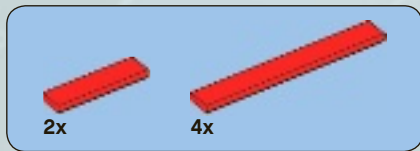

43

waypoint 1

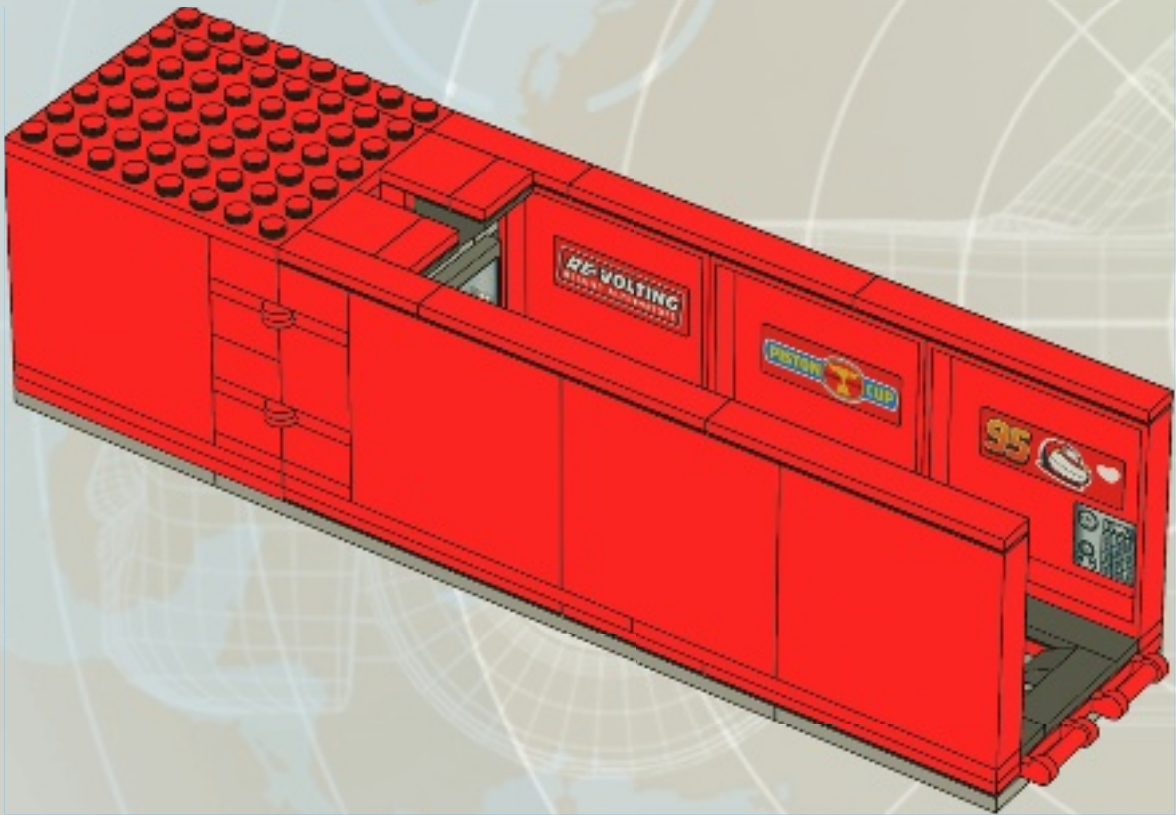

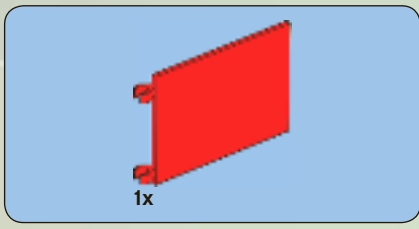

44

target
acquired

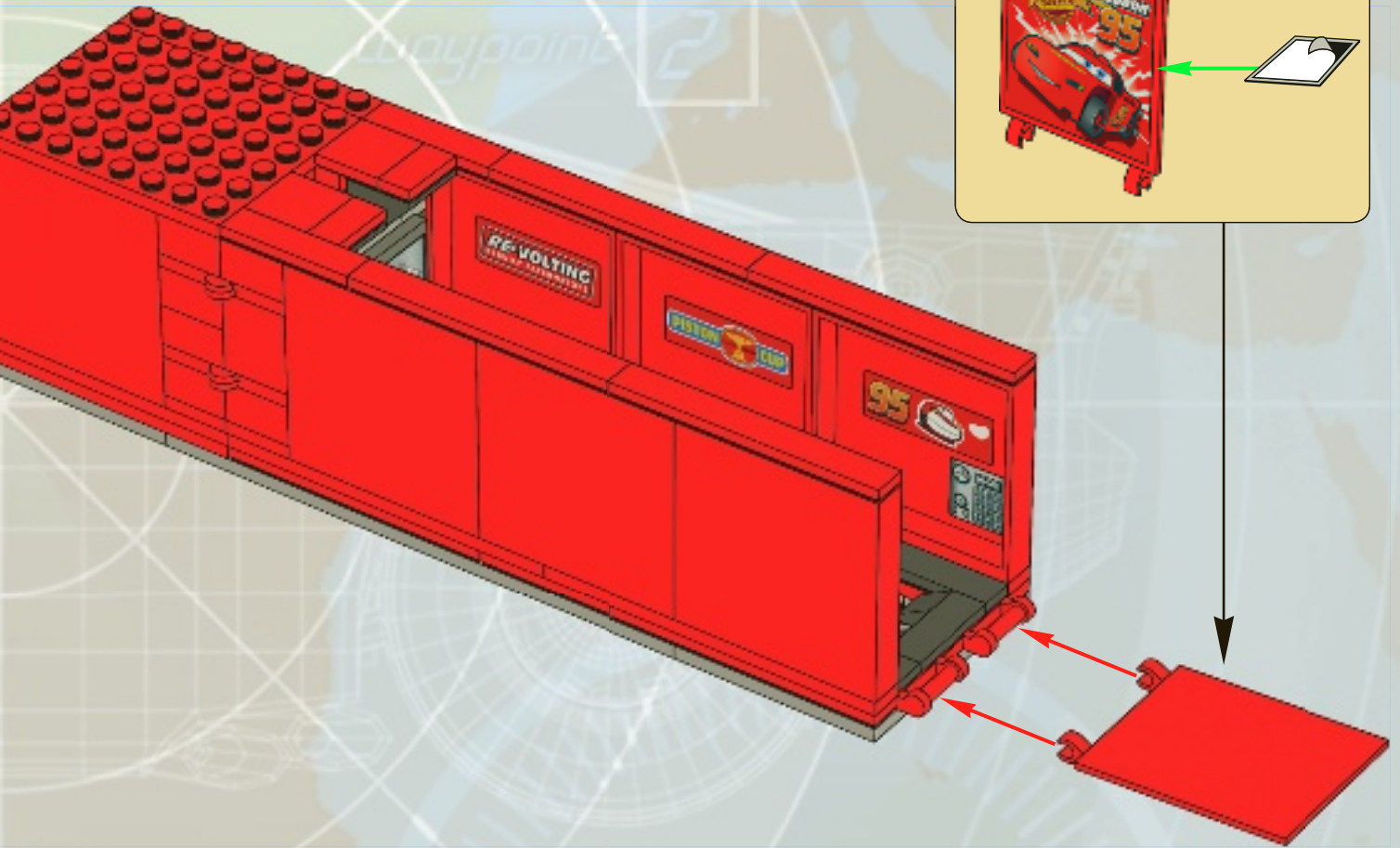

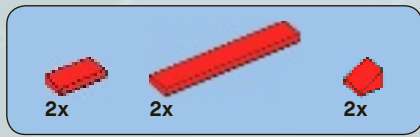

45

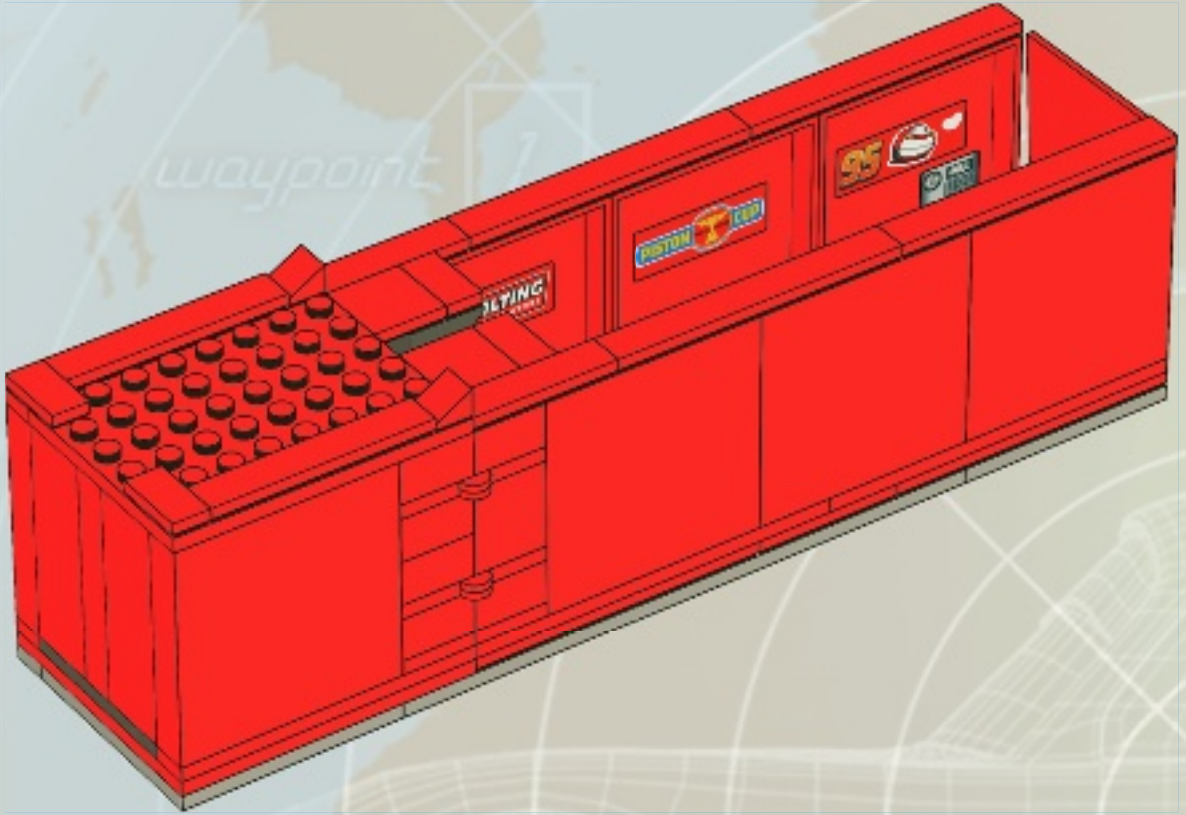

46

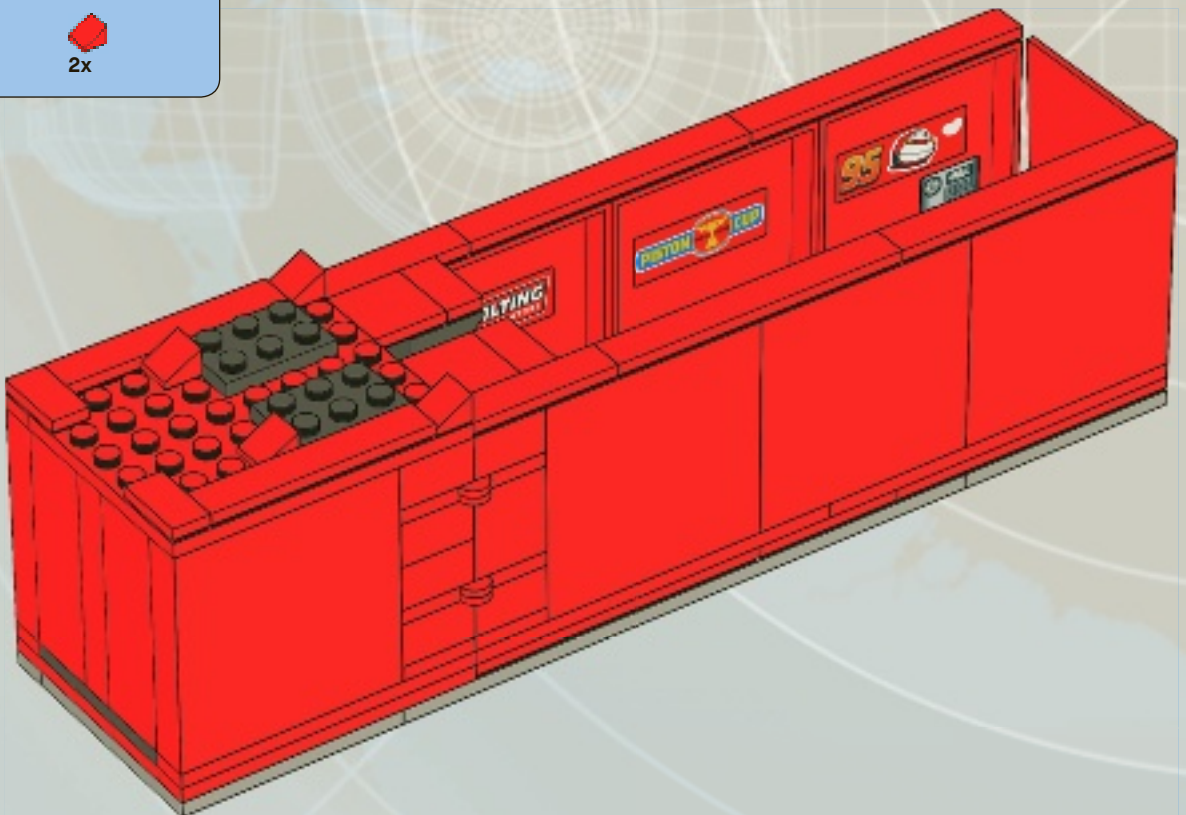



47

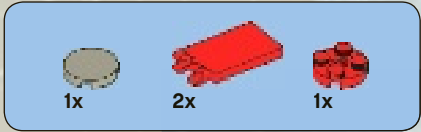
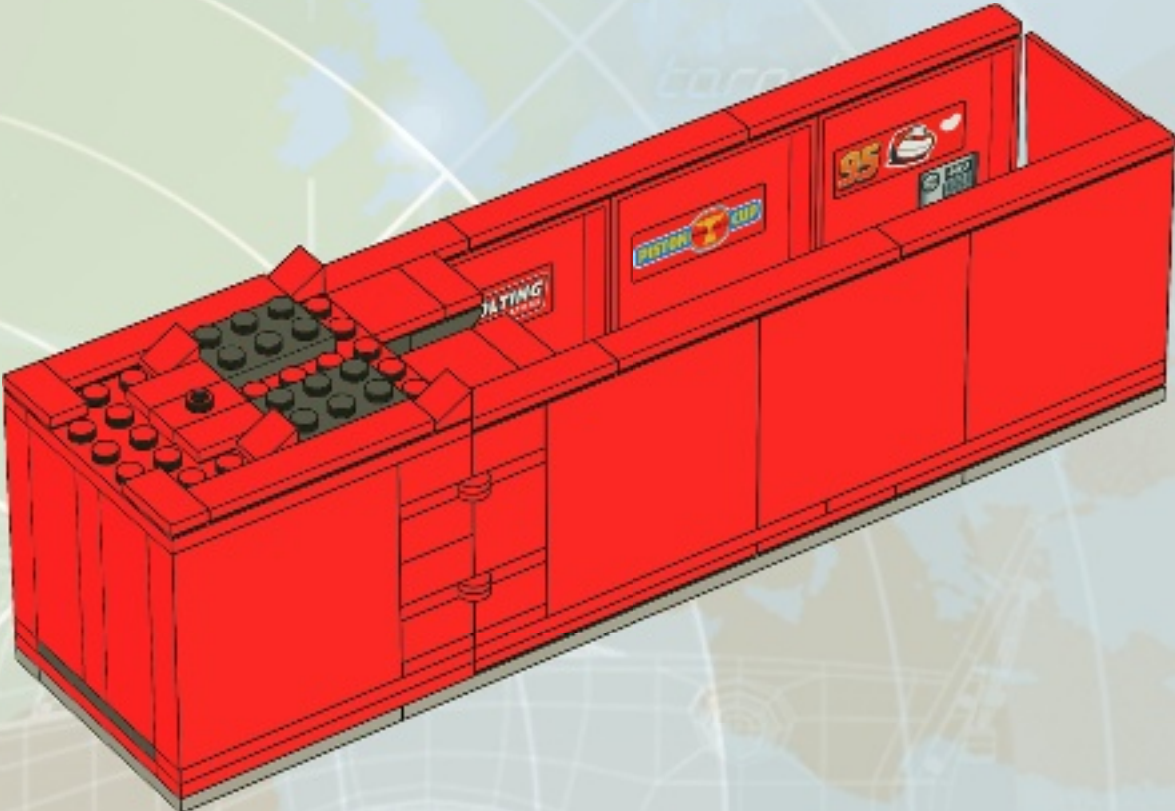

48

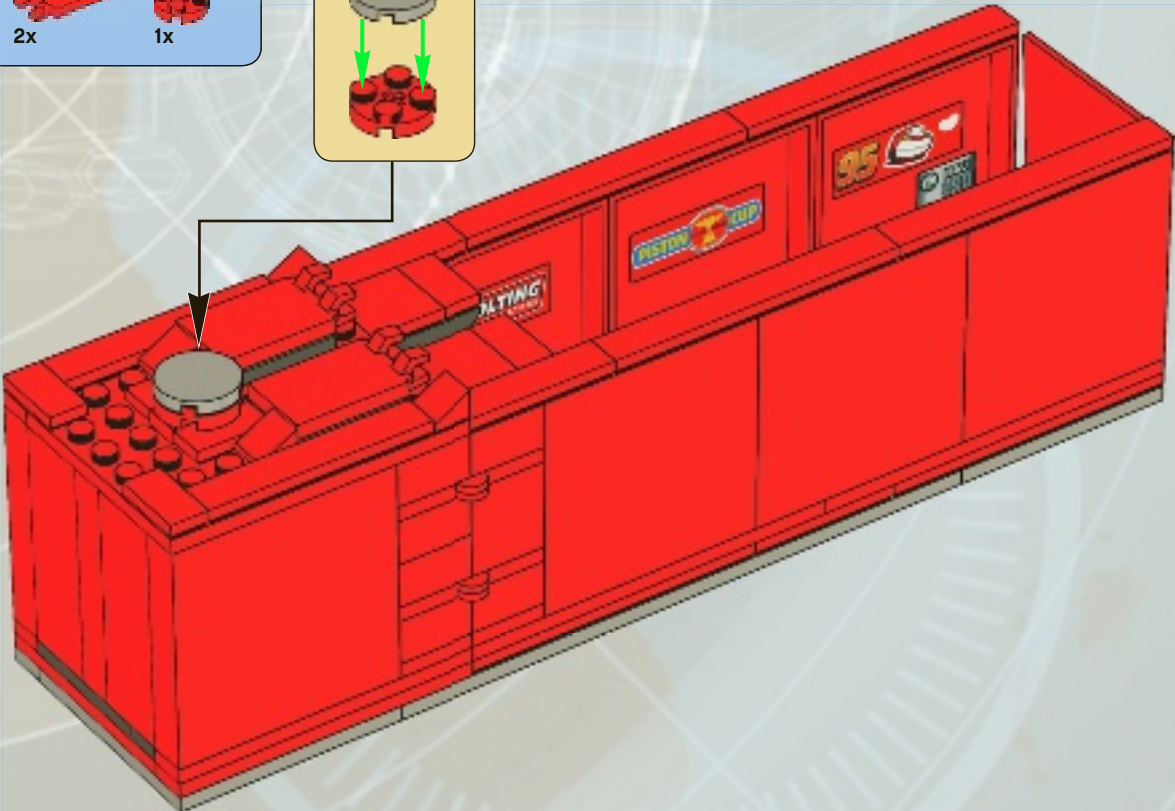
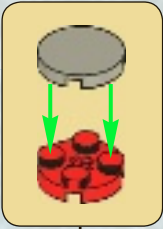

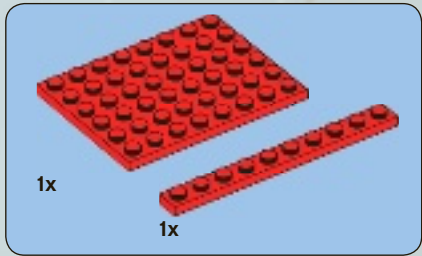
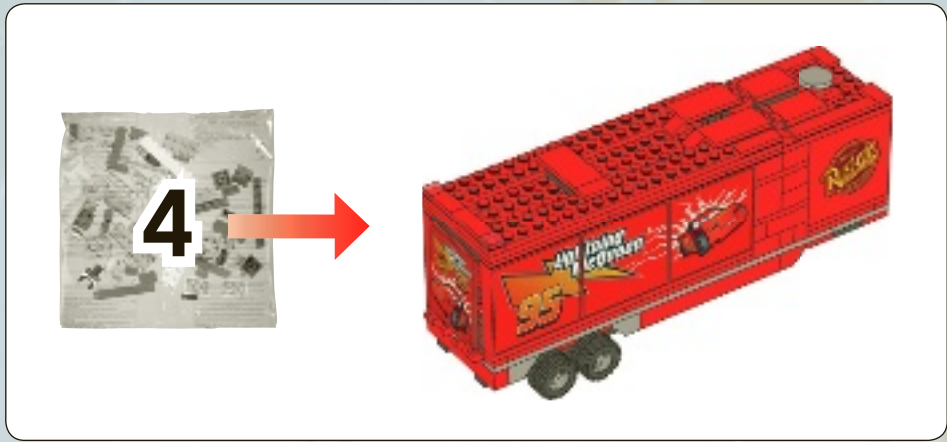

1

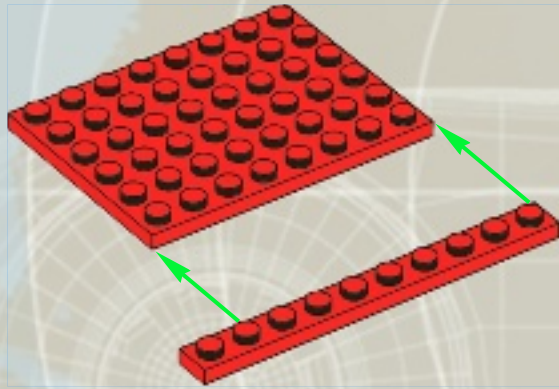

2

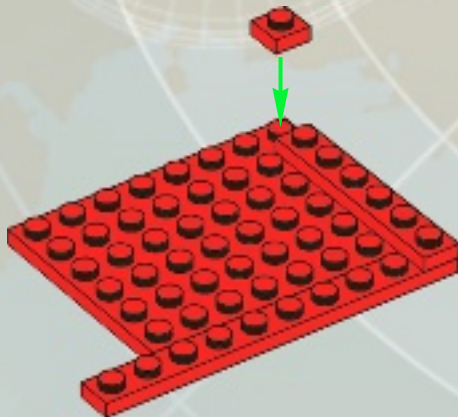

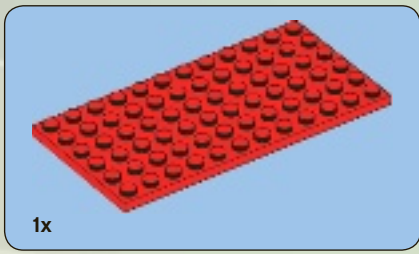

3

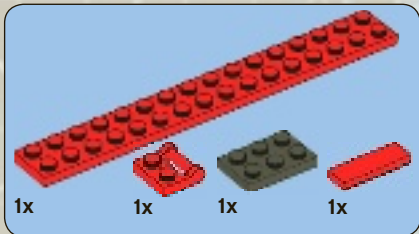
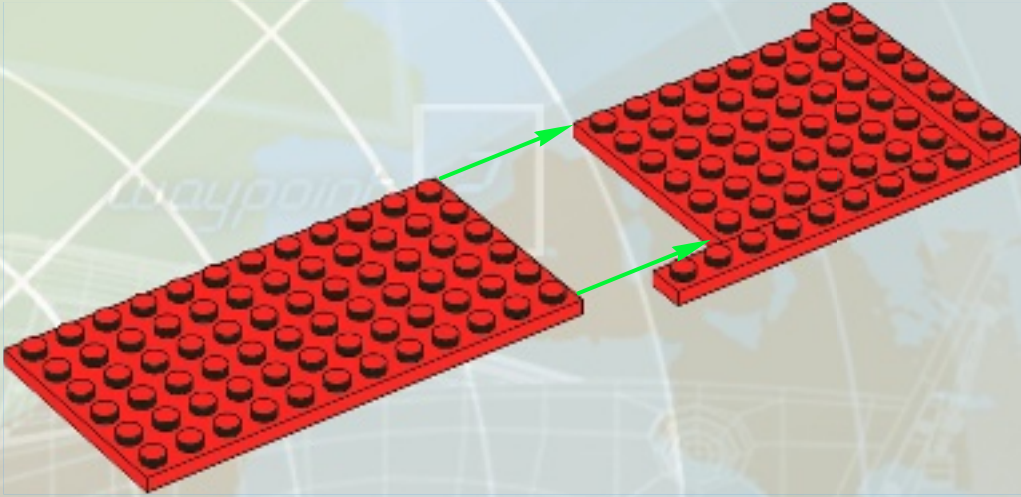

4

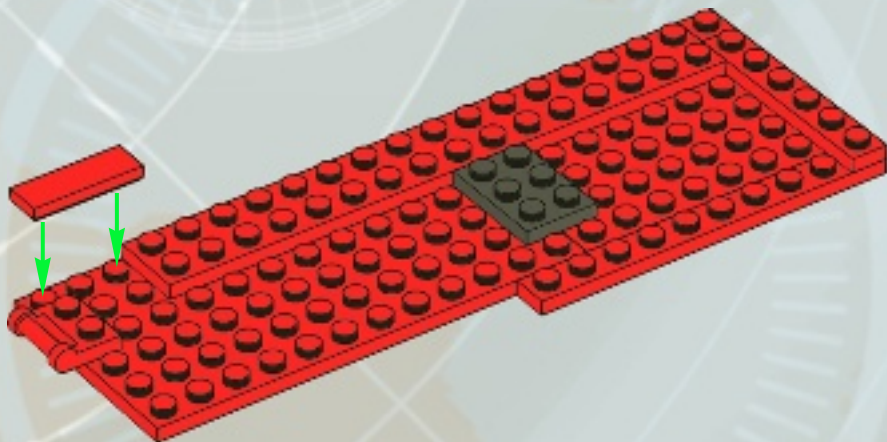

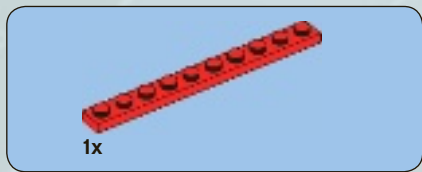

5

waypoint 1

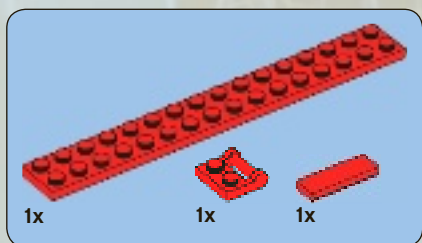
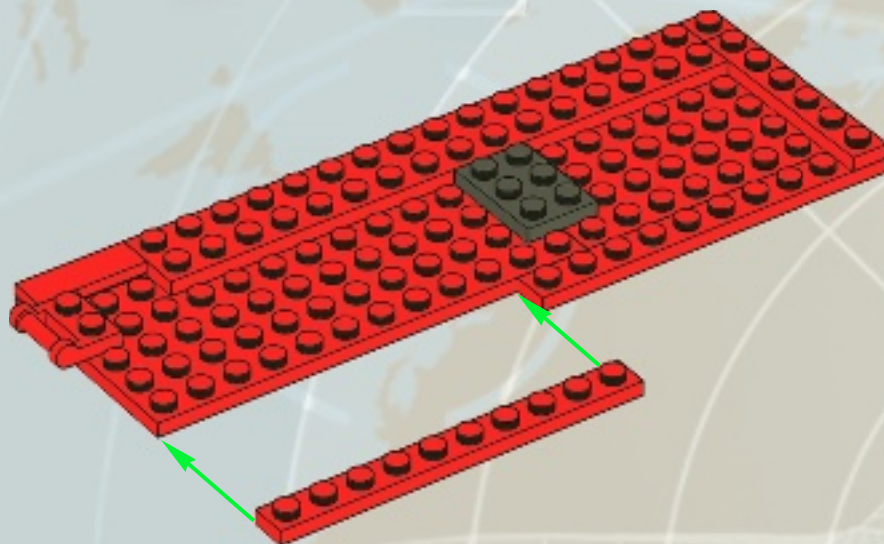

6

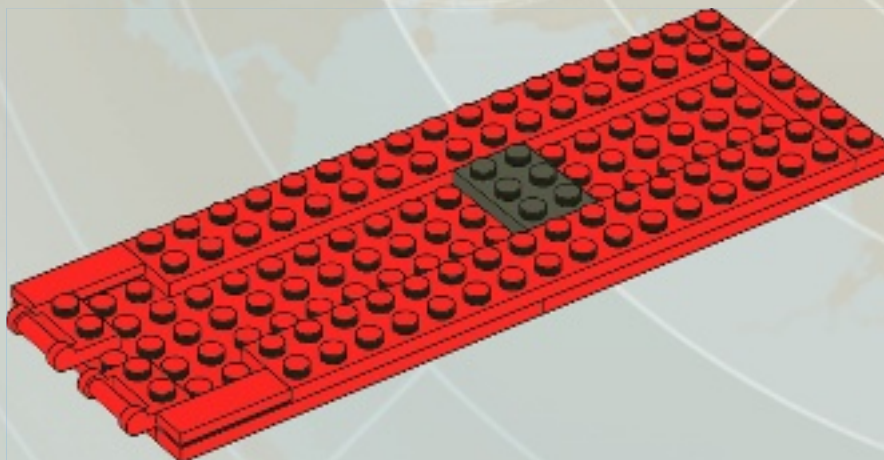

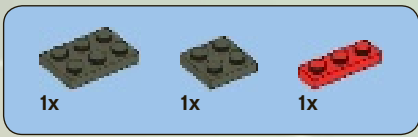

7

target
acquired

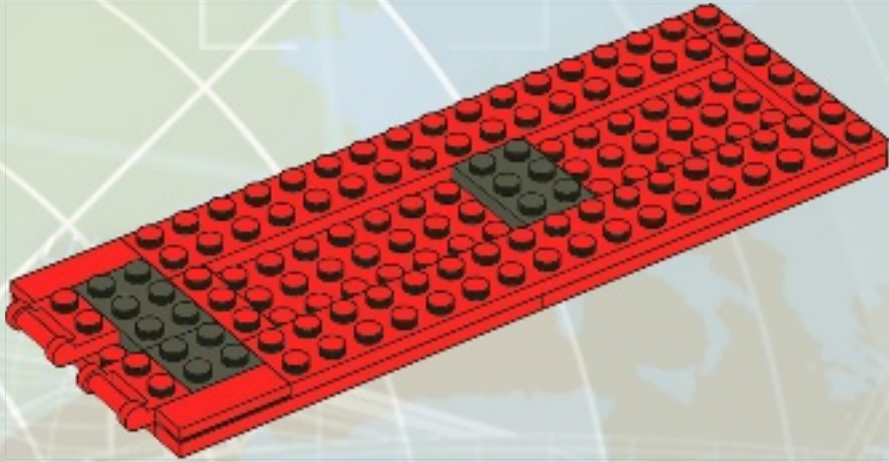

8

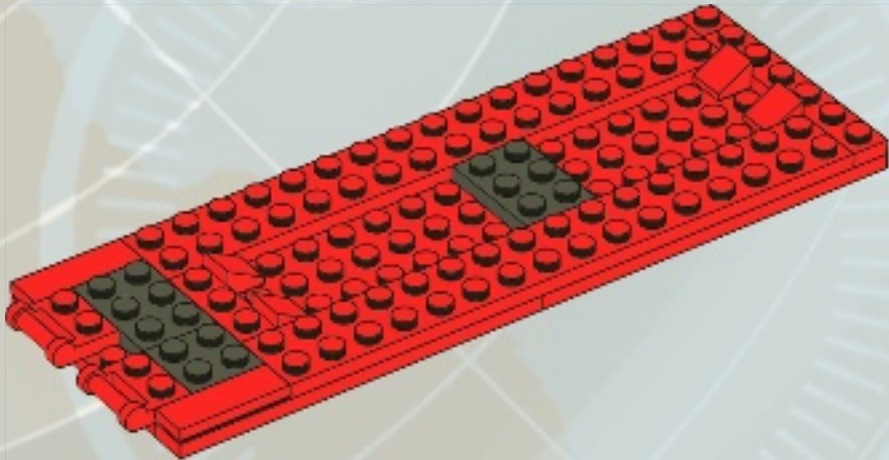

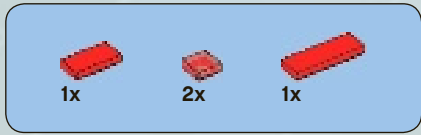

9

waypoint 1

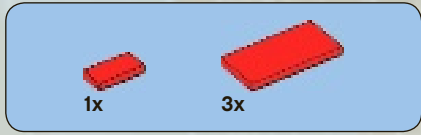
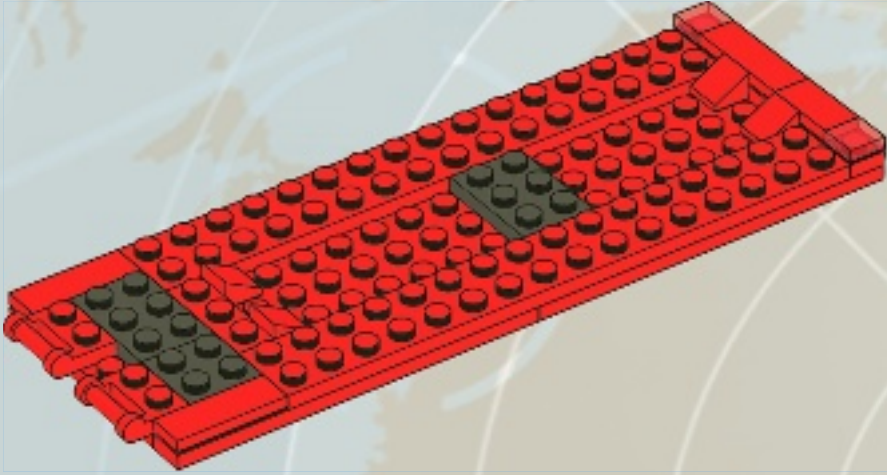

10

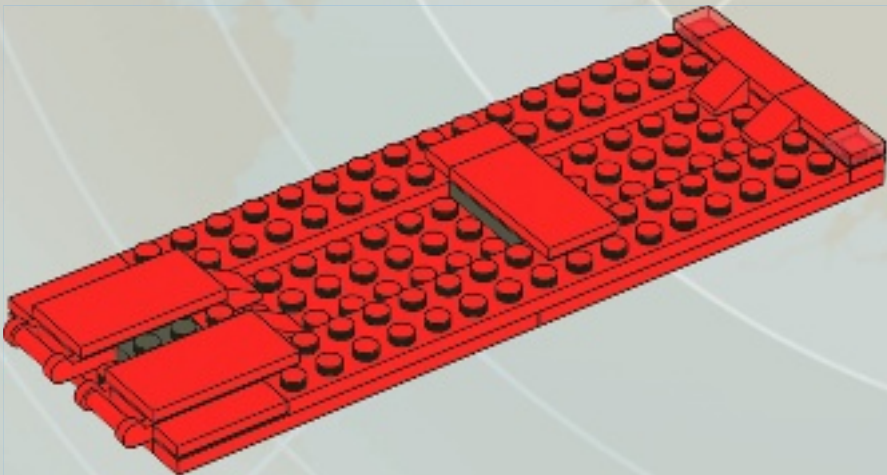

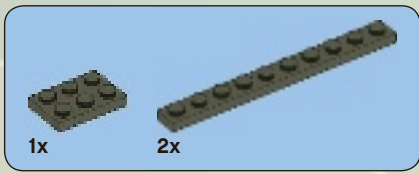

11

target
acquired

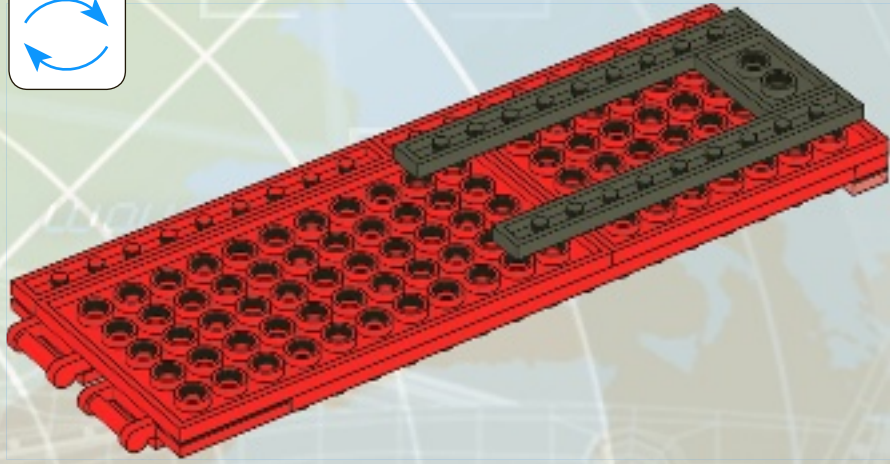
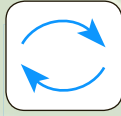

12

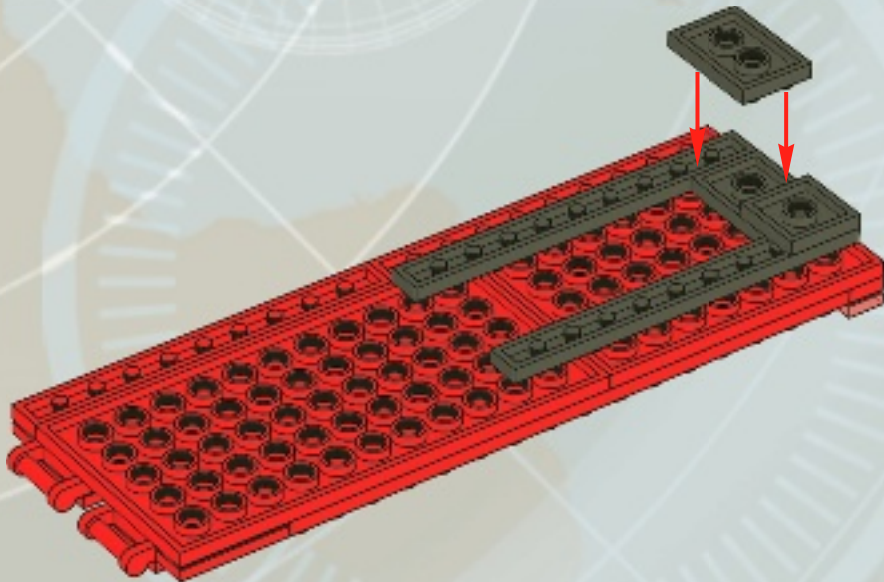

13

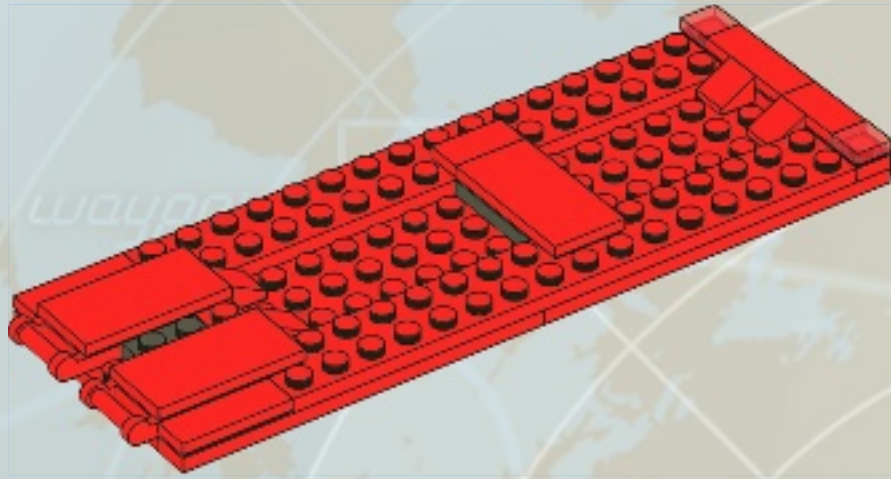

14

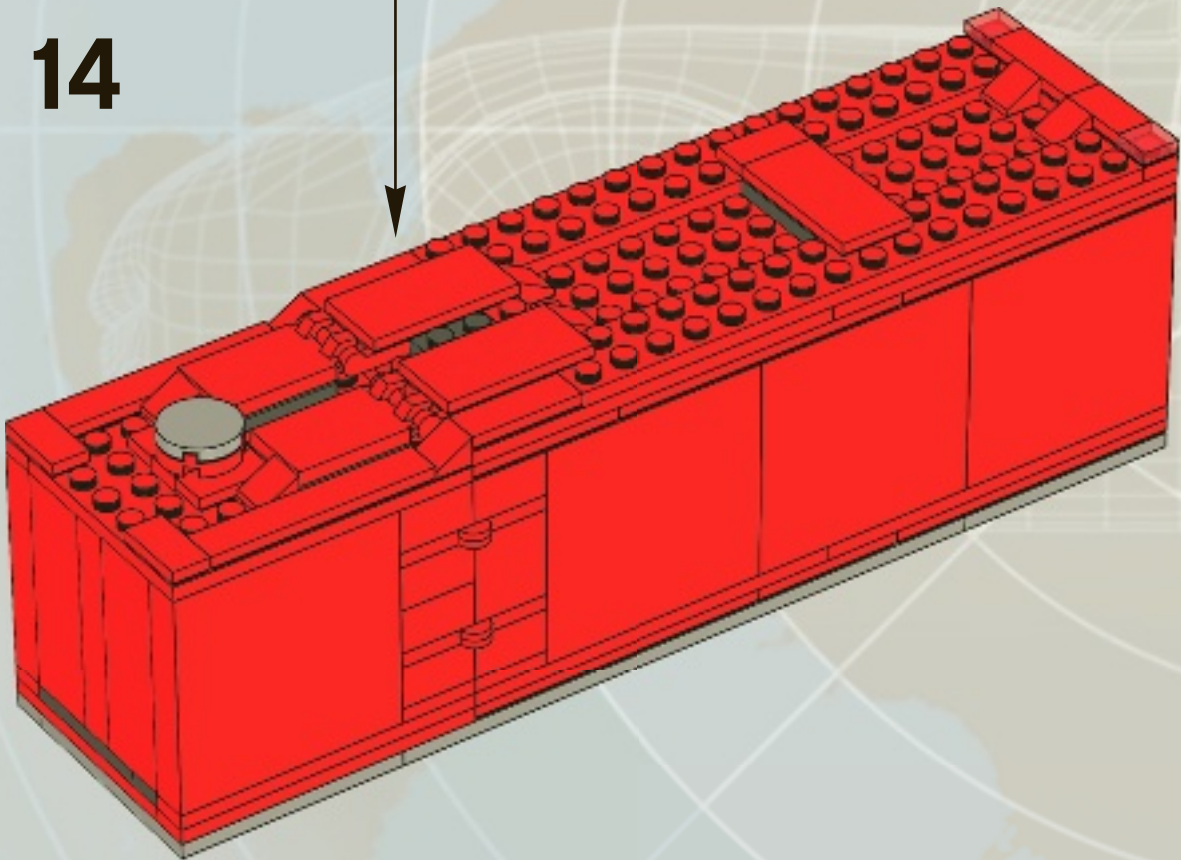

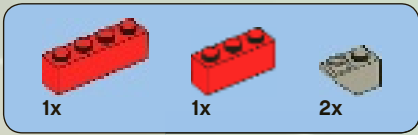

15

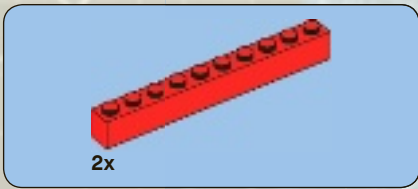
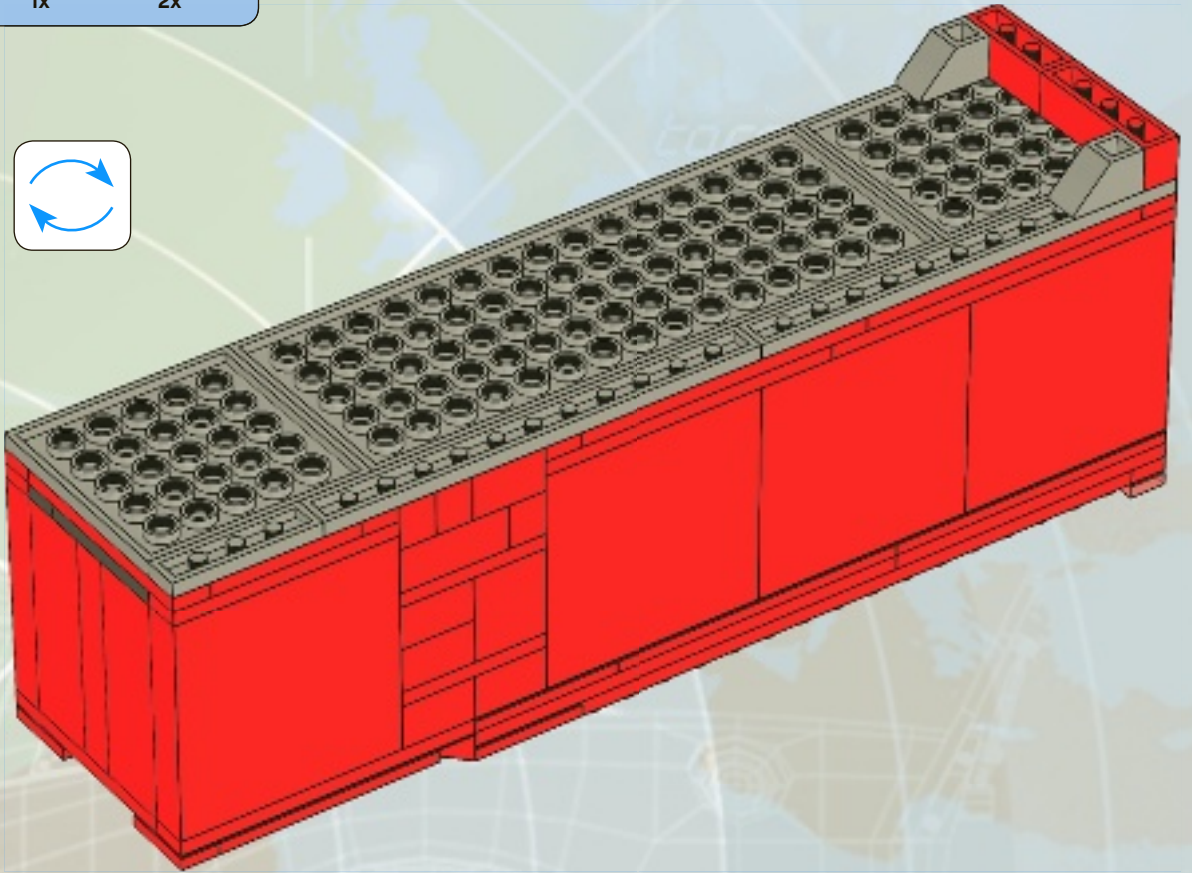

16

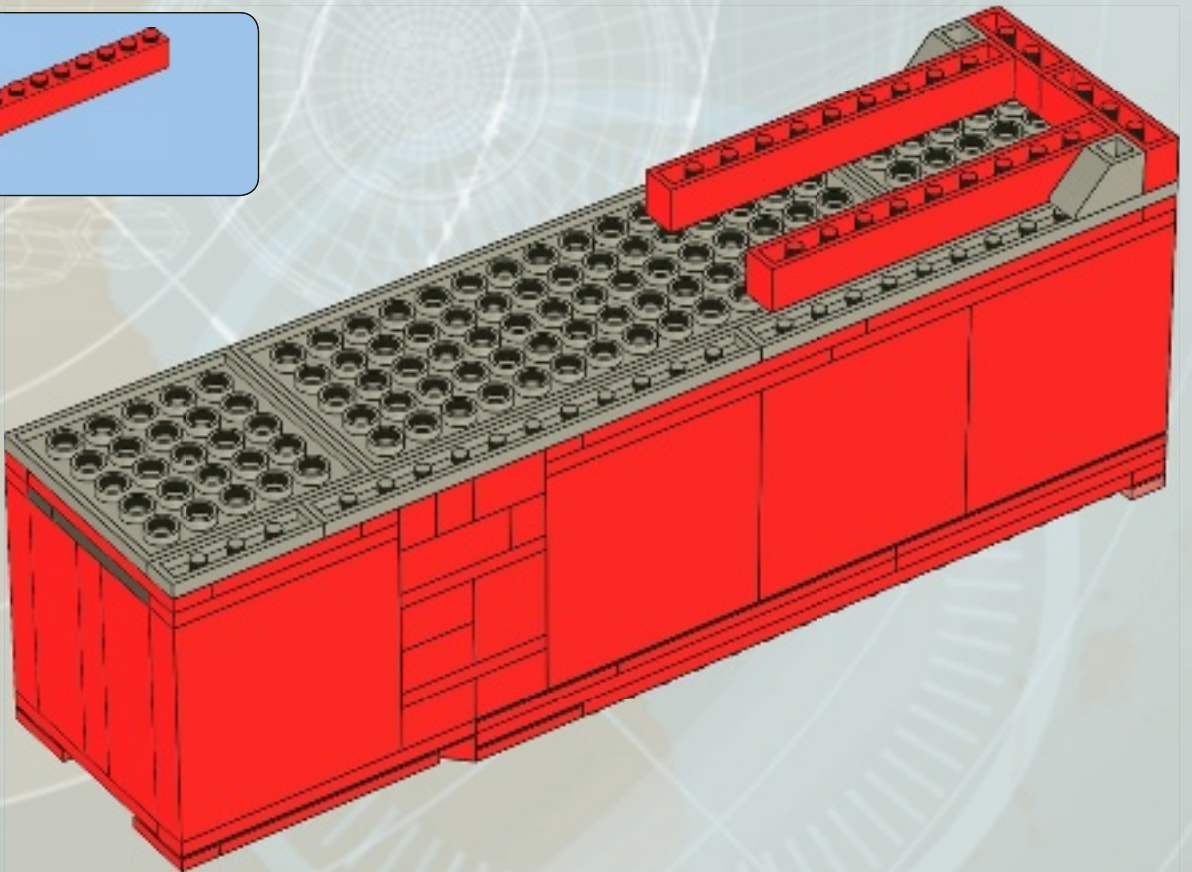



1x



2x

17

waypoint 1

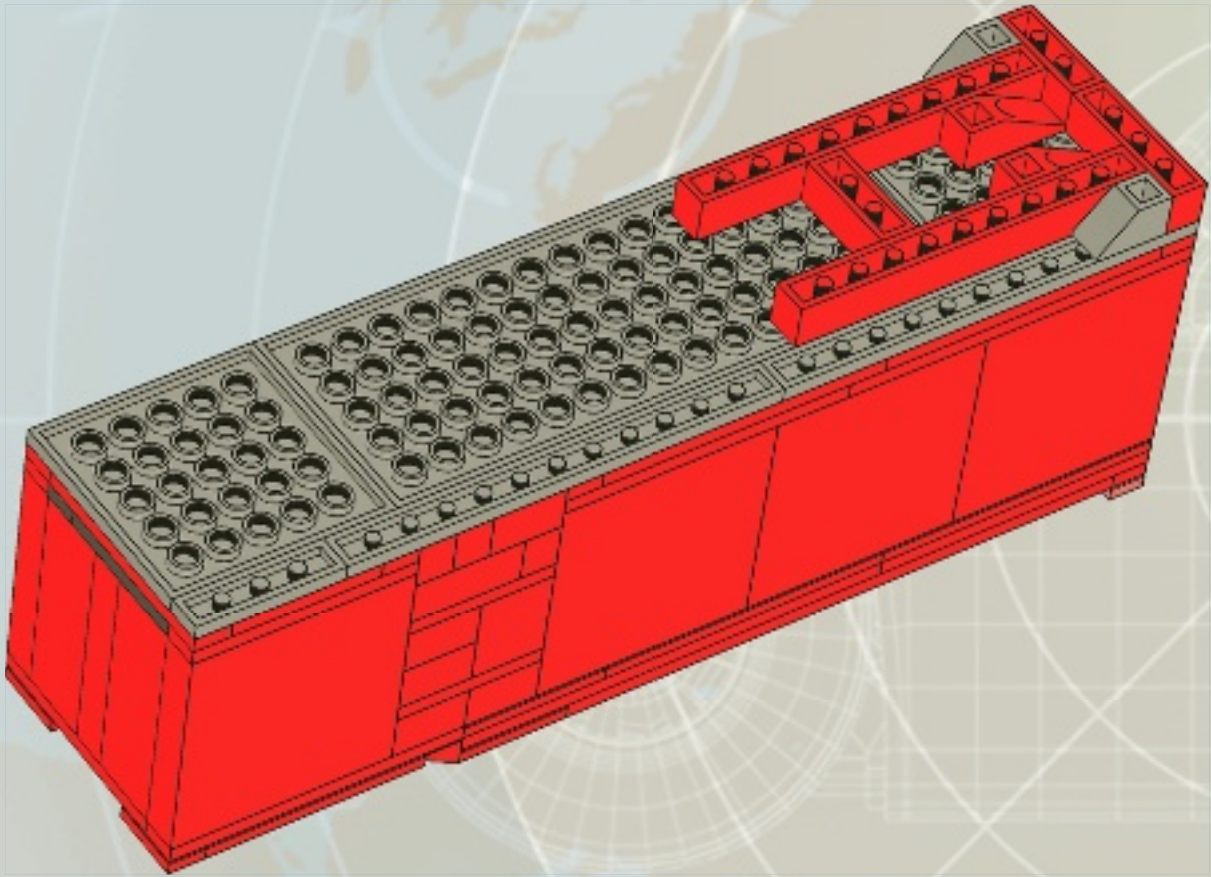

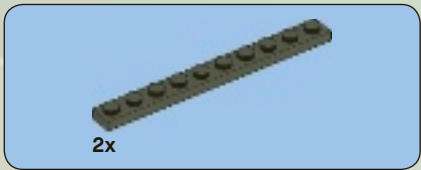

18

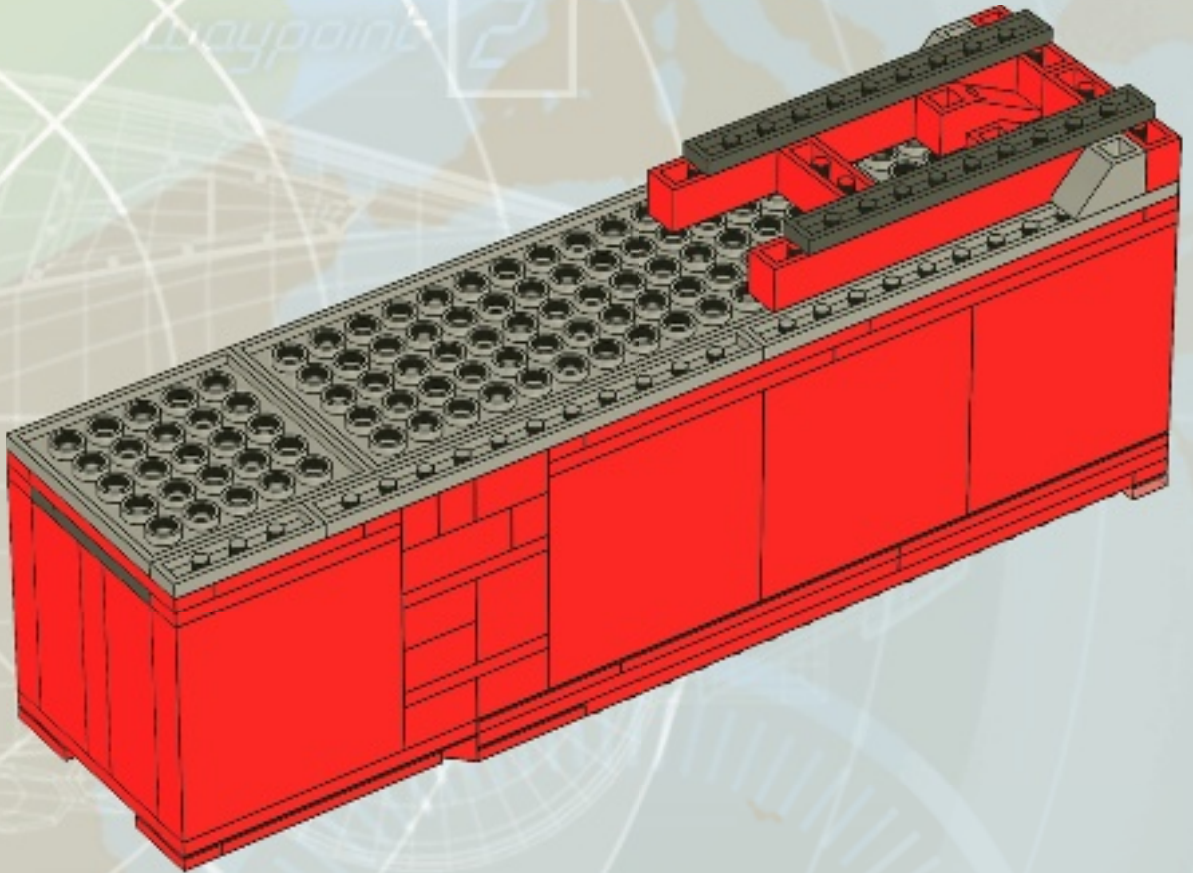

*target
acquired*

waypoint 2

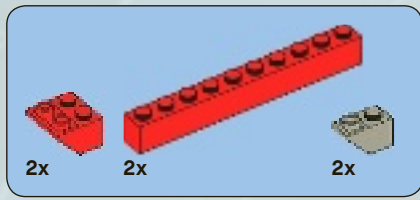

19

waypoint 1

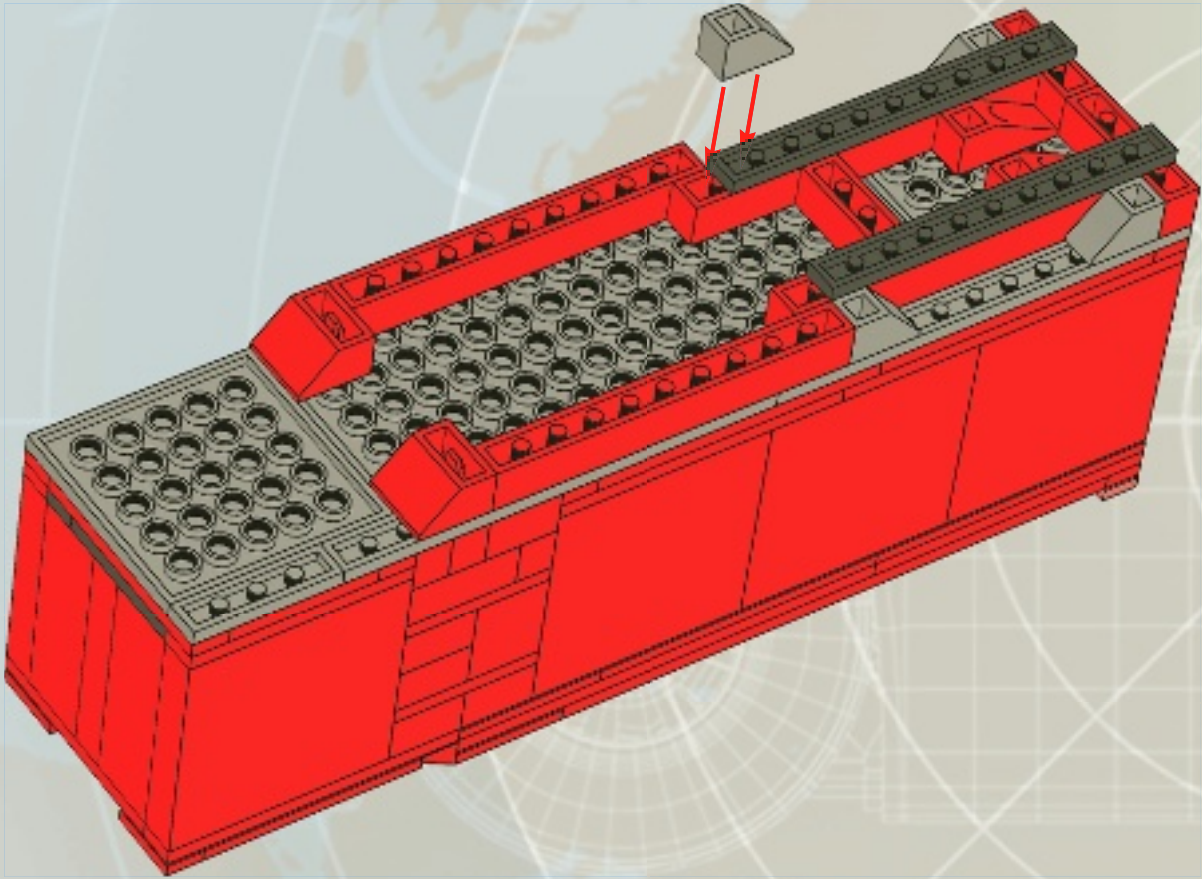



20

target
acquired

waypoint 2

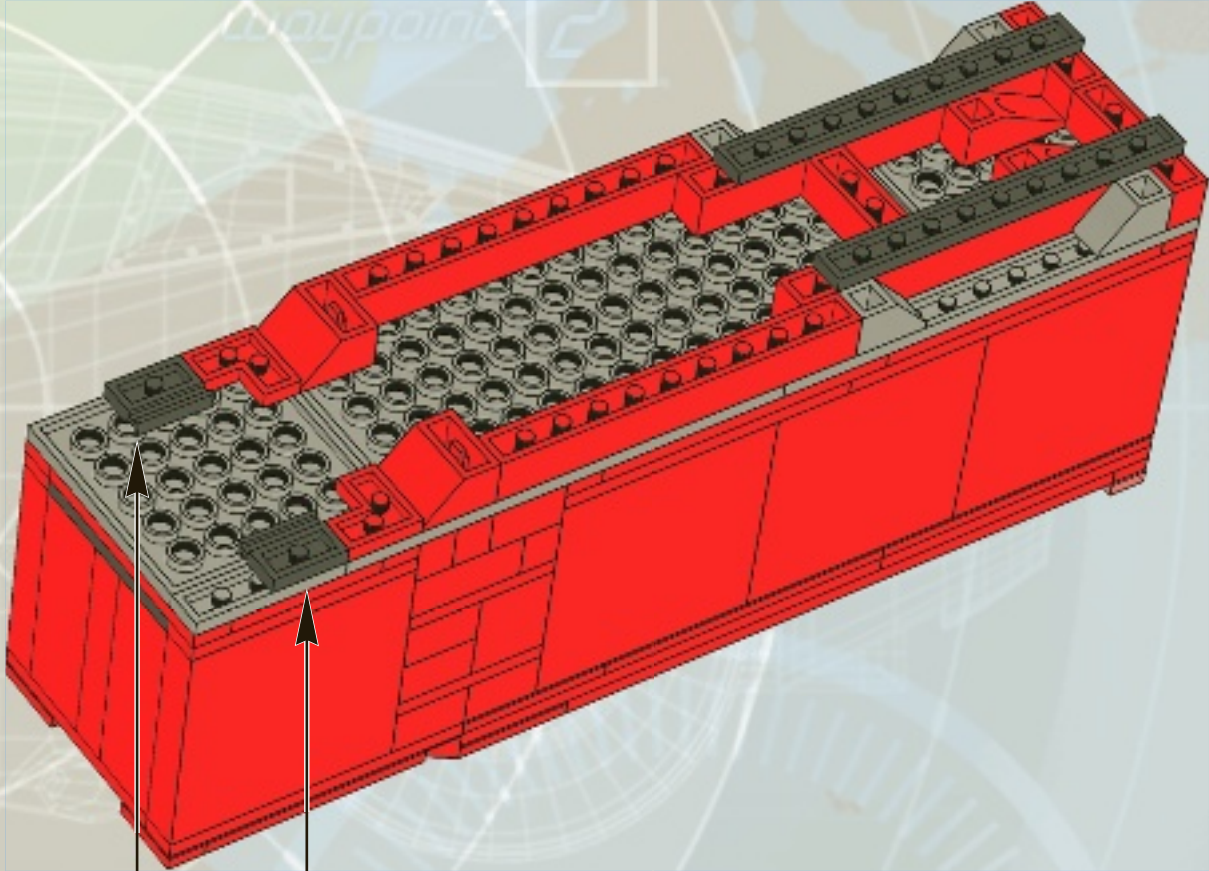

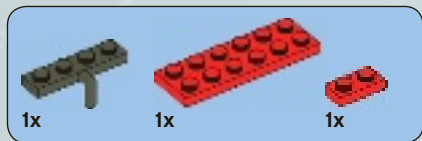

21

waypoint 1

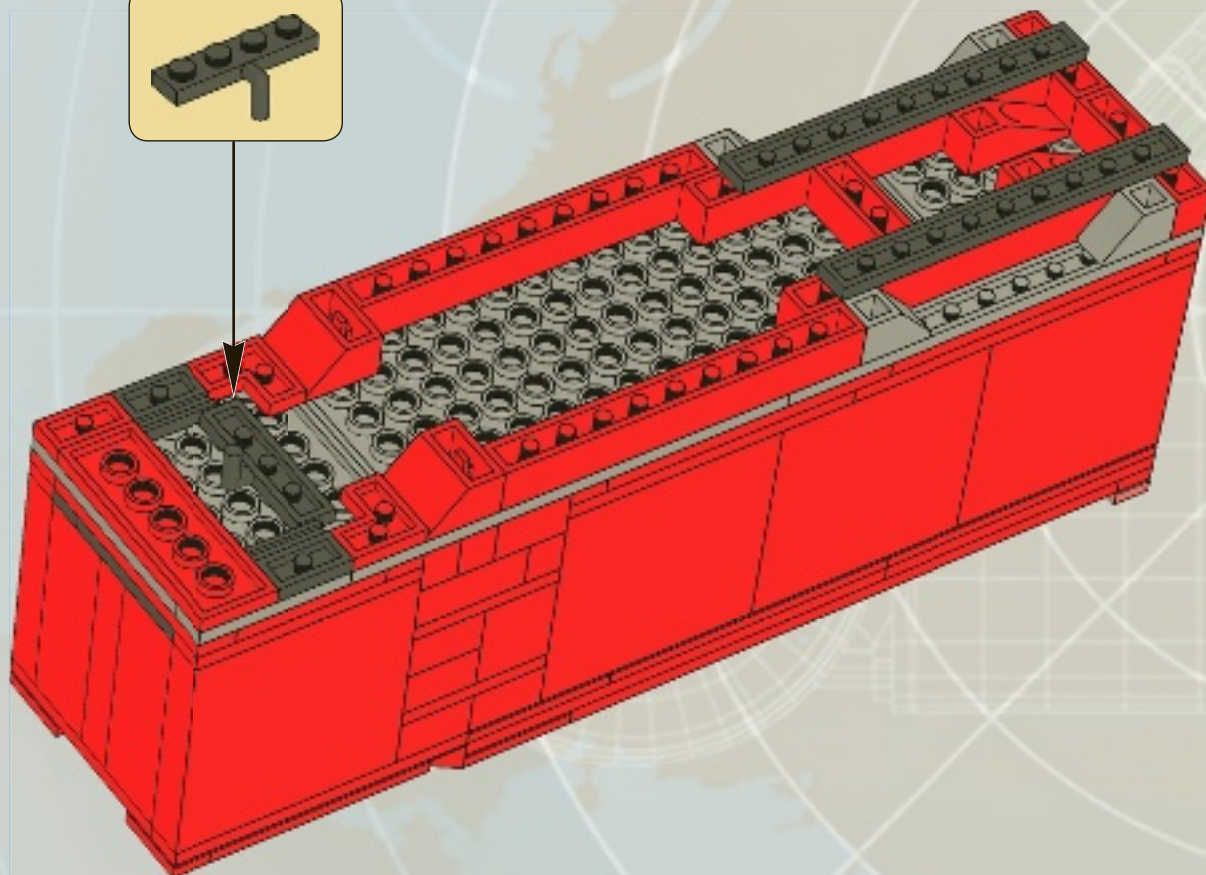
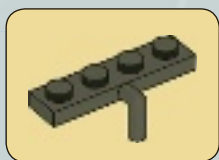

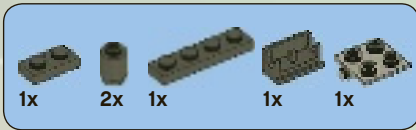

22

*target
acquired*

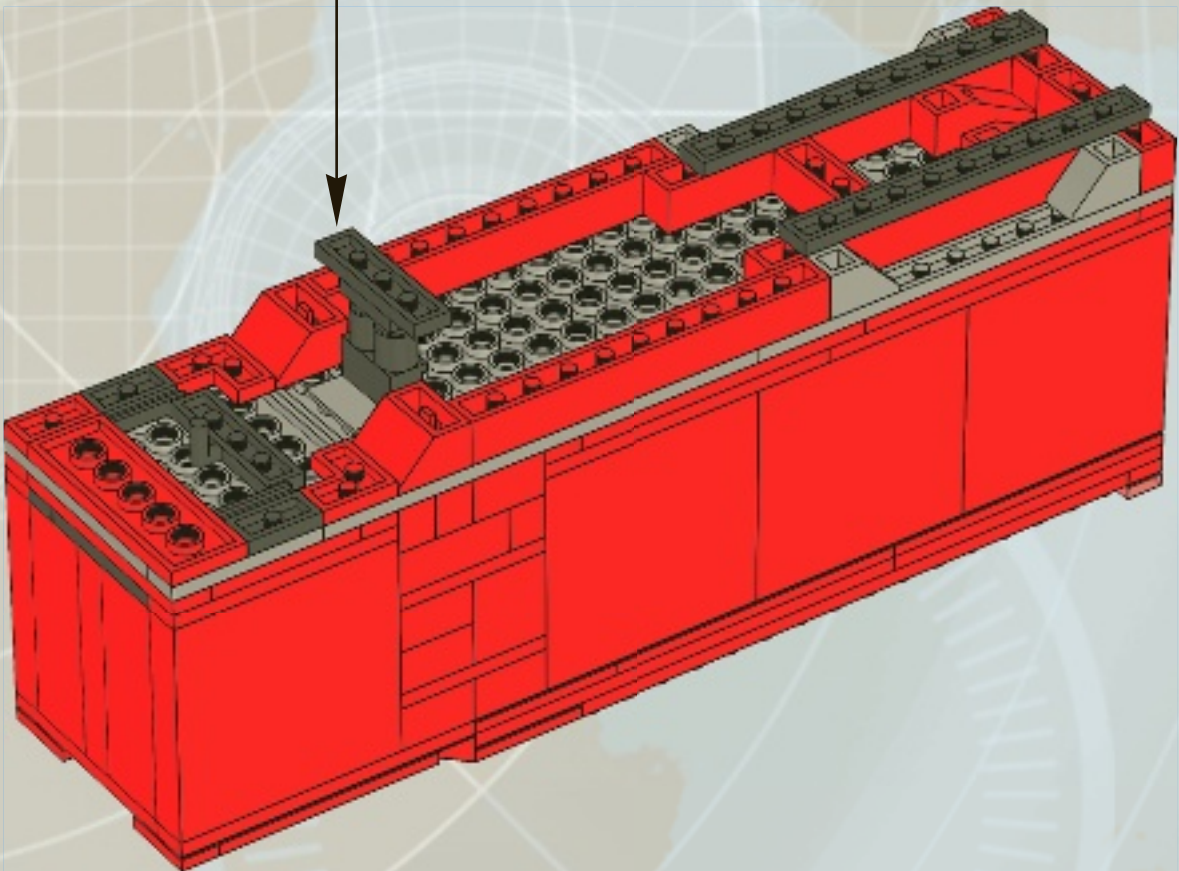
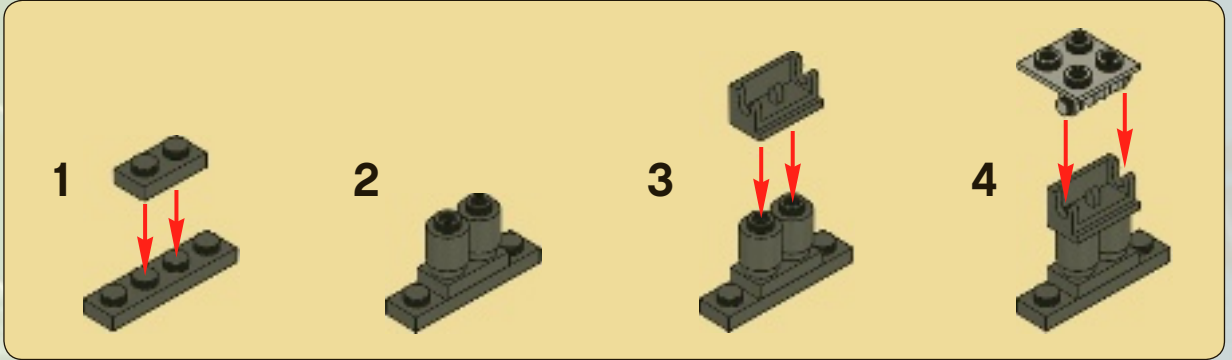



1x

1



1x

2



1x

3



4x

4

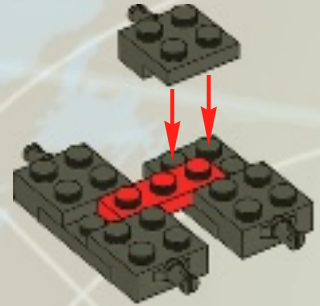

2x

5

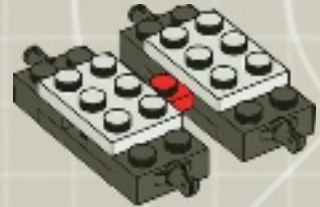

2x

6

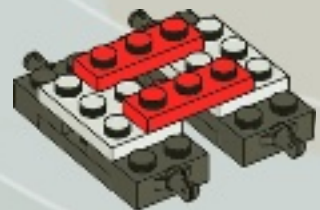



7



23

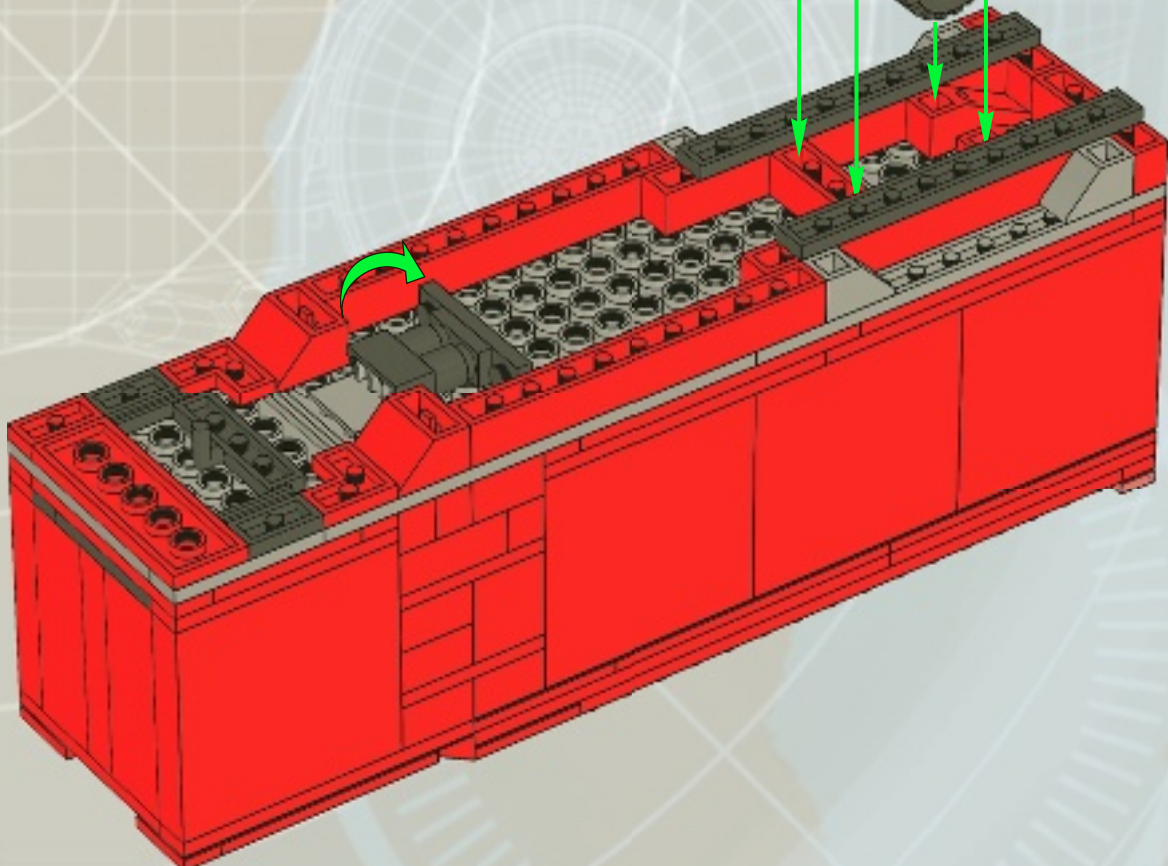
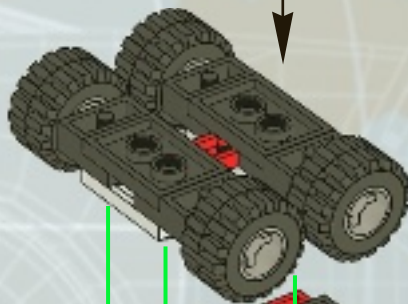

waypoint 1

24

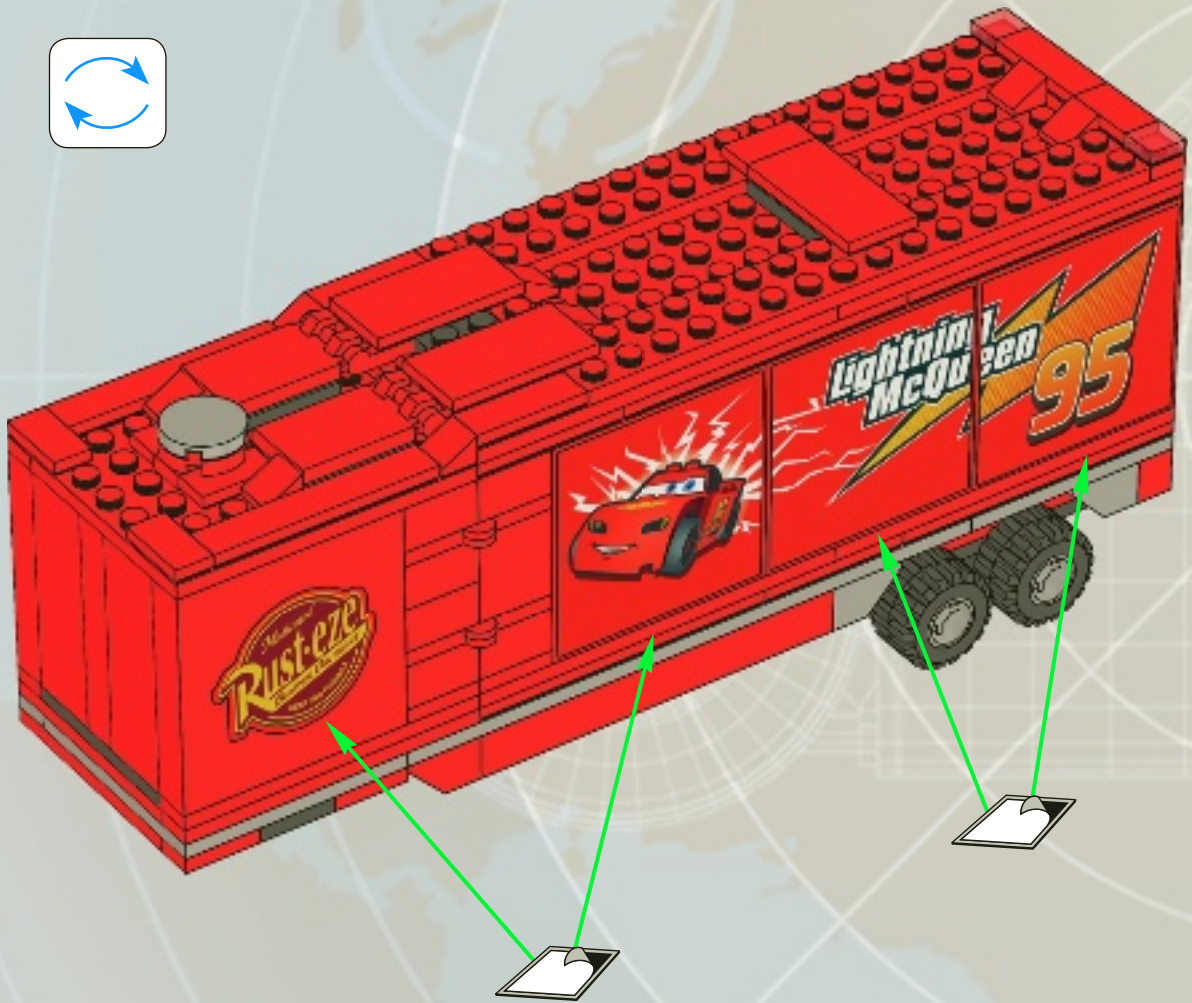

target
acquired

25

waypoint 2

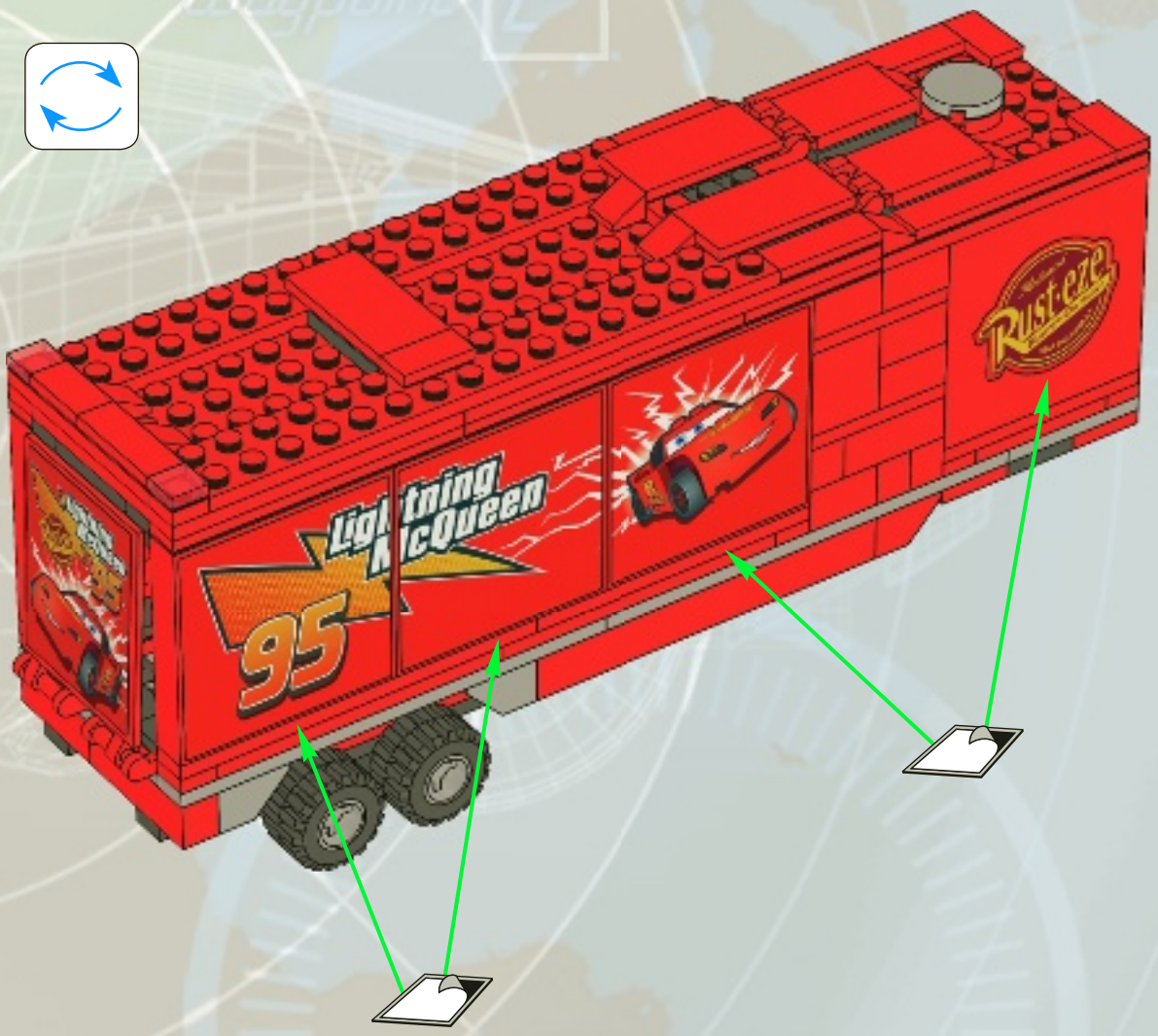
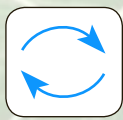

waypoint 1

26



27



target
acquired

waypoint 2



Rust-eze
Rust-eze
Rust-eze

**Lightning
McQueen**
95

Mack

95

Rust-eze

95





5x
302301

4x
235721

1x
4116617

1x
303221

2x
4282742

2x
302101

2x
362221

2x
371021

3x
303421

2x
4616800

1x
4523403

4x
300121

3x
4560179

6x
447721

2x
4530734

8x
4504379

5x
300921

1x
4616125

2x
303621

2x
74230

1x
300521

1x
4181138

1x
4616123

1x
4617409

1x
4180504

1x
4212410

4x
611121

7x
302021

1x
4617409

1x
4180533

5x
300421

2x
654121

3x
379421

2x
428221

1x
403221

4x
4143832

1x
4622728

6x
366621

2x
4505067

4x
4613159

2x
4212414

1x
4617273

2x
4113858

8x
4505067

1x
4613132

2x
300321

2x
366021

1x
4243814

1x
4617399

6x
307021

5x
4226876

2x
428721

1x
379521

1x
4616120

4x
302421

2x
300221

2x
609121

4x
346021

1x
4616119

4x
302321

4x
301021

2x
4631357

6x
416221

4x
306921

10x
306921

2x
302221

8x
242021

10x
362321

3x
4533742

3x
243121

1x
4616127

1x
4617271

1x
379523

2x
4143005

1x
370126

5x
4504382

2x
366526

2x
366026

3x
371026

1x
4243819

1x
379526

2x
416226

1x
303226

4x
447726

2x
362226

1x
301026

2x
306226

1x
300526

2x
4618852

1x
302426

3x
302326

4x
302226

2x
4558170

8x
302126

3x
243126

4x
4246901

10x
4514560

1x
393726

6x
379426

1x
4556158

2x
4107761

4x
448826

1x
3004326

2x
615726

1x
408326

1x
4140303

1x
370926



1x
4143199



2x
428226



2x
4211474



1x
4211733

2x
4514846

2x
4594238

6x
4211350

2x
4244627

6x
4211496

2x
4613165

1x
4211480

2x
4263192

10x
4211764

4x
4211437

2x
4518653

3x
4211429

7x
4211445

2x
4211395

1x
4211881

4x
4211389

2x
4211613

3x
302328

1x
4211085

1x
4598769

1x
4509911

1x
4211042

2x
3003941

1x
4213119

1x
4159007



Customer Service

Kundenservice

Service Consommateurs

Servicio Al Consumidor

www.lego.com/service or dial



00800 5346 5555 :

1-800-422-5346 :





LEGO.com/CARS





8486



8200, 8487



8423, 8639



8638



8639



8424



8639



8638



8426



8201, 8487



8424



8638



8639



8426, 8639



8638



8487



8487



8638



8206



8639



8639



8487



8426



8638



8423



8486



8487



8206, 8484



WIN!



Go to www.LEGOsurvey.com/product
to fill out a survey for a chance
to win a cool LEGO® Product.
No purchase necessary.
Open to all residents where not prohibited.

www.LEGOsurvey.com/product

GEWINNE!

Nimm an der Umfrage auf www.LEGOsurvey.com/product teil und hab die Chance ein cooles LEGO® Produkt zu gewinnen!

Die Teilnahme am Gewinnspiel führt zu keinerlei Kaufverpflichtungen. Teilnahme in allen nicht ausgeschlossenen Ländern möglich.

WIN!

Ga naar www.LEGOsurvey.com/product, vul een enquêteformulier in en maak kans op een cool LEGO® product.

Geen aankoopverplichting. Iedereen mag deelnemen, uitgezonderd ingezetenden van landen waar een enquêteverbod geldt.

GAGNE!

Visite www.LEGOsurvey.com/product pour répondre à un questionnaire et avoir une chance de gagner un produit LEGO® très cool!

Aucune obligation d'achat. Ouvert à tous les résidents des pays autorisés.

当てよう!

www.LEGOsurvey.com/product

アンケートにご記入ください。当選者は必ずして、製品を差し上げます。

お買い上げの必要はありません。禁止されていない限り、すべての皆様にご利用いただけます。