

**LEGO**



8638



1

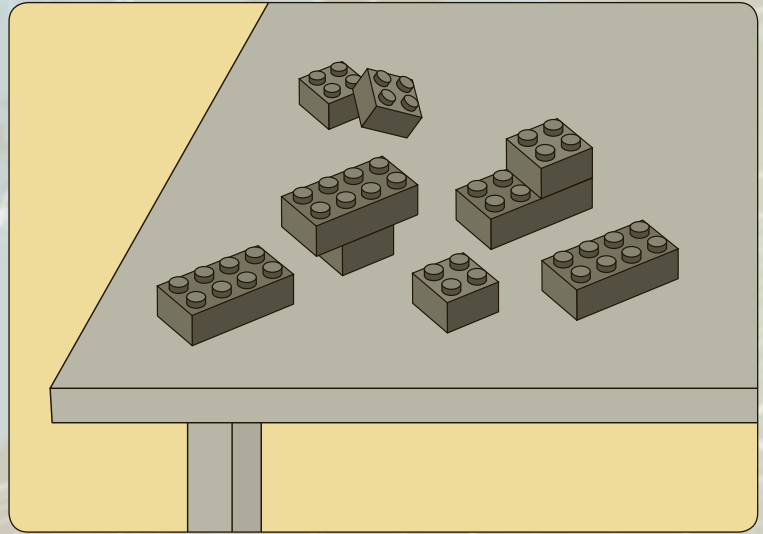
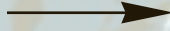
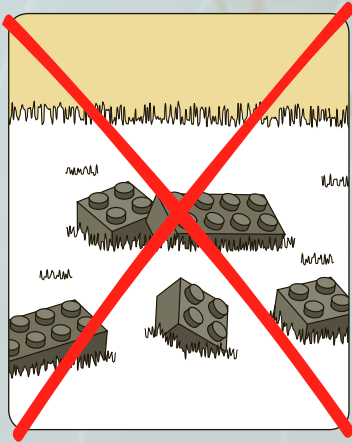

2



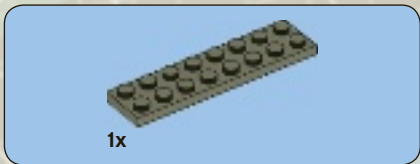
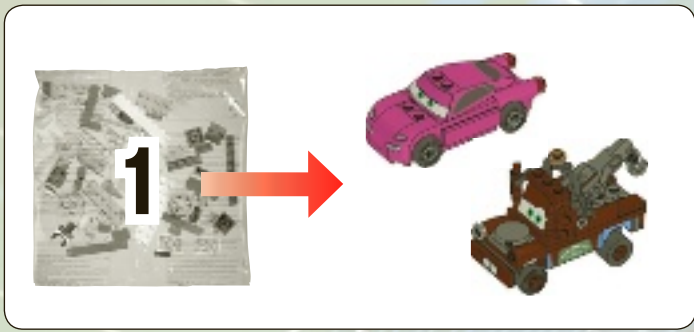

**1**



**2**



**3**

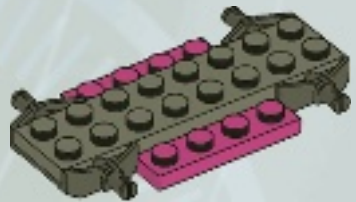



aypoint

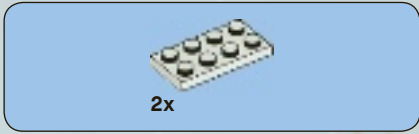

4

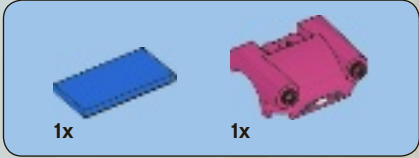
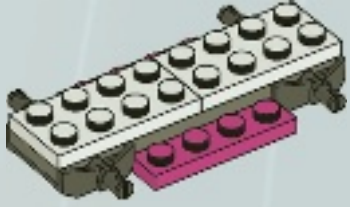

5

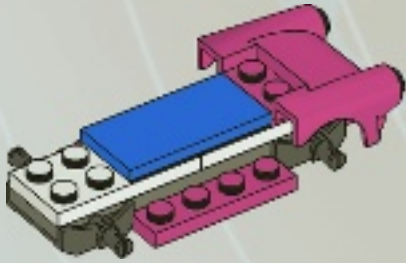

6

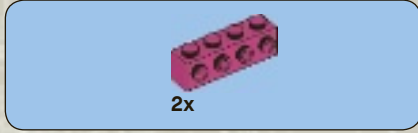
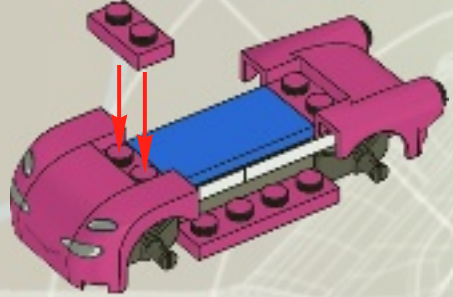

7

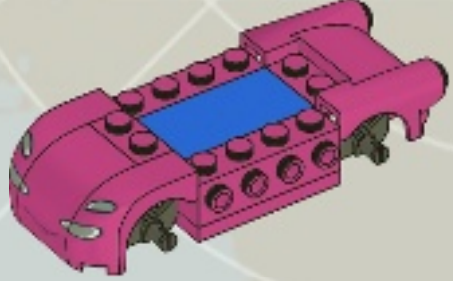

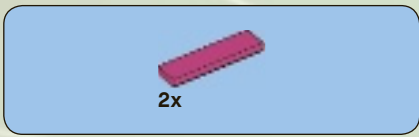

8

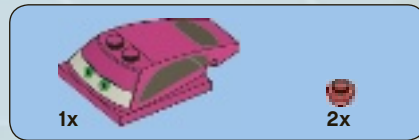
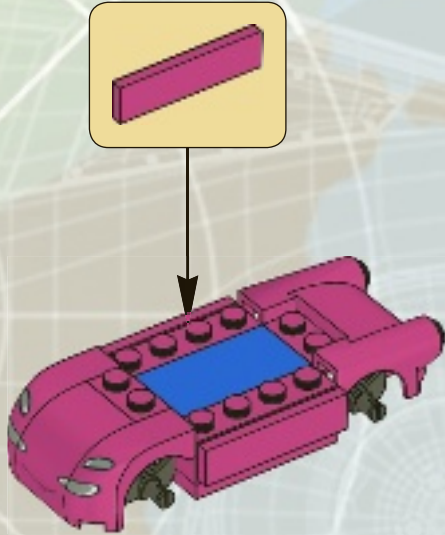

9

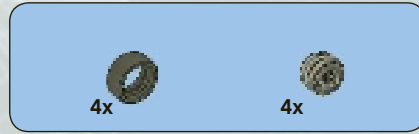

10



aypoint 1

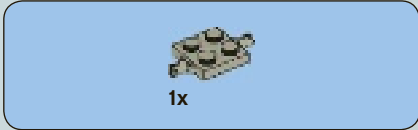

1

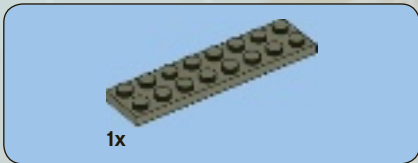

2

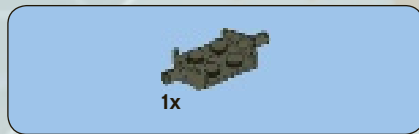

3



4

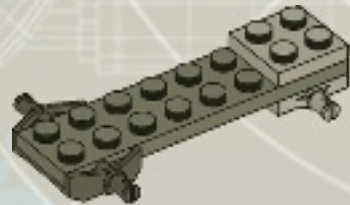

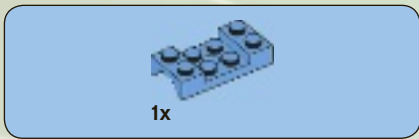

5

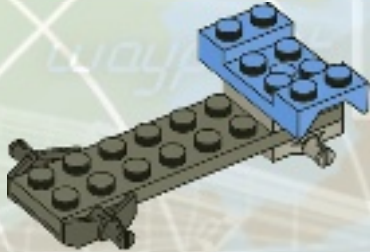

6

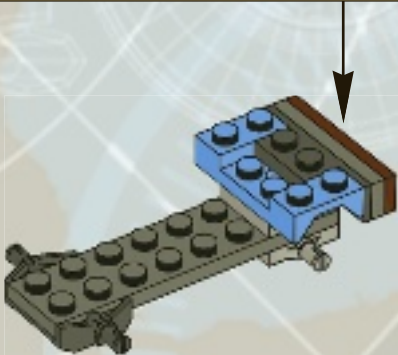
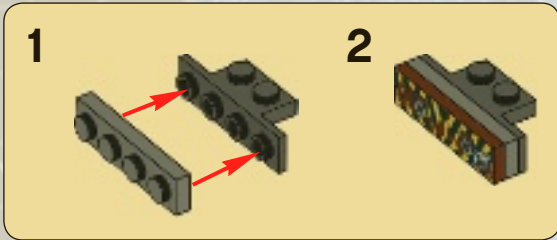

7



8

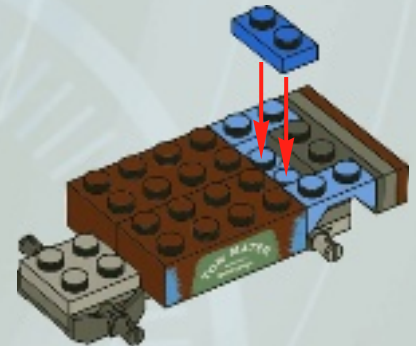



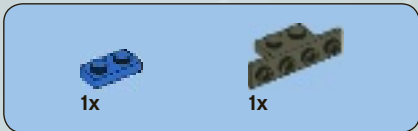

9



10

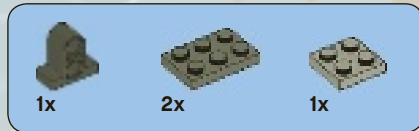

11



12

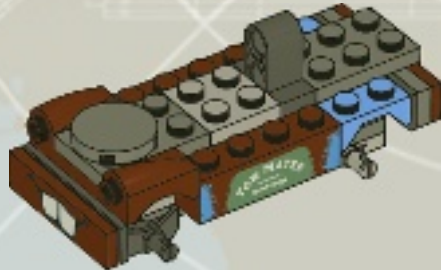





# 13

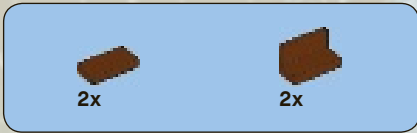
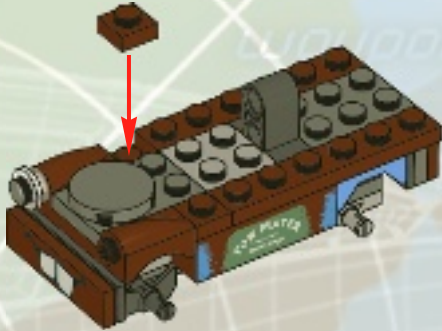

# 14

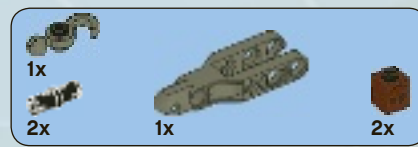
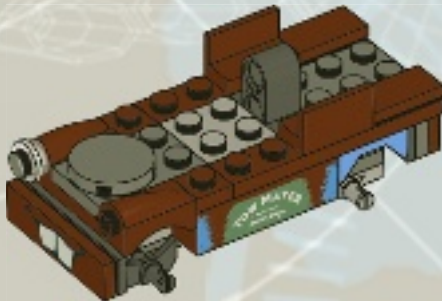

# 15

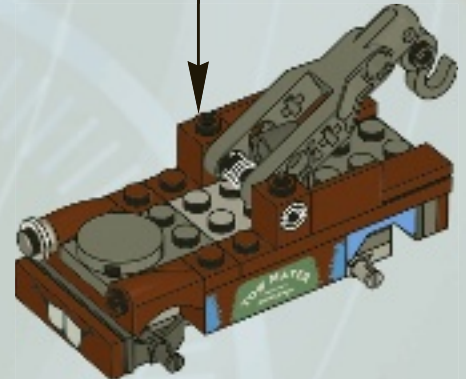
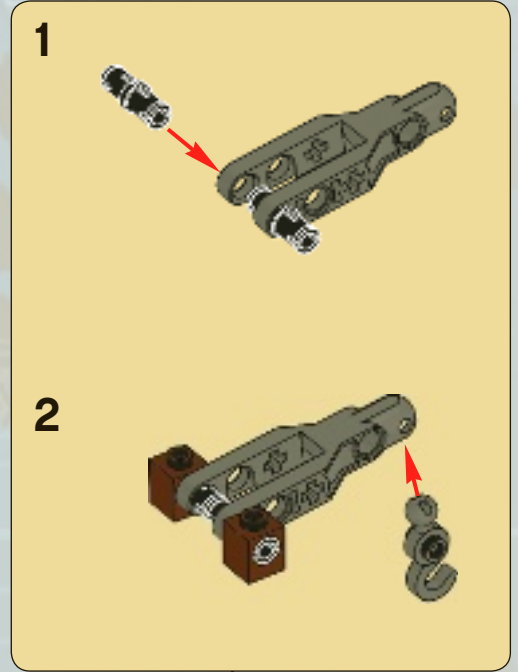



1x

16

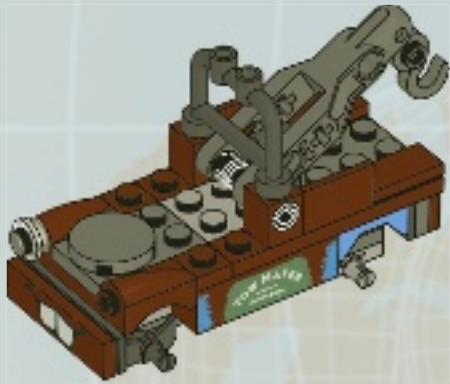

2x

17

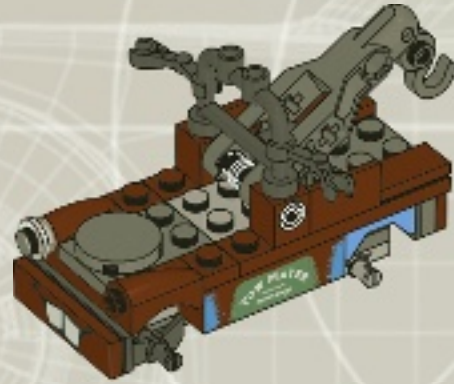



2x

# 18

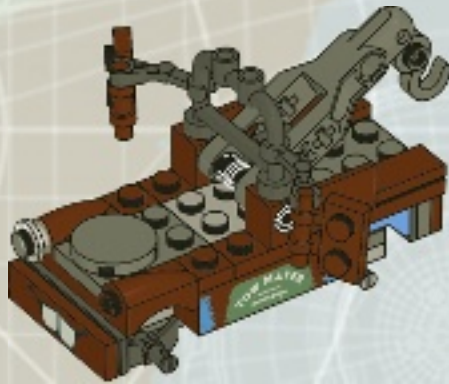

1x

# 19

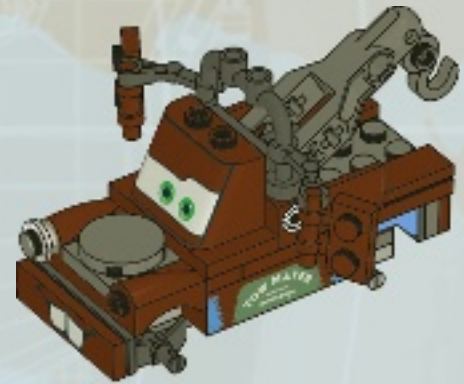





20



21

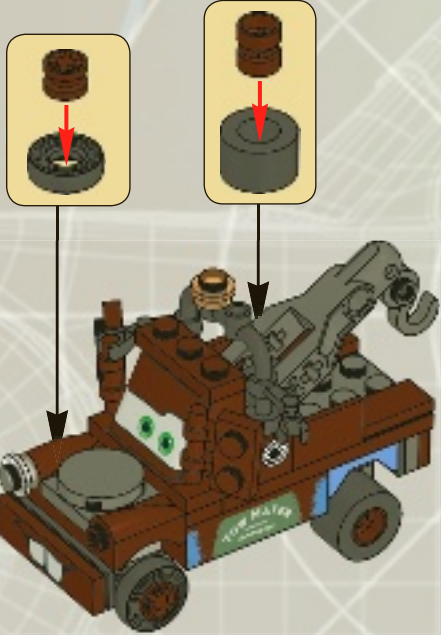

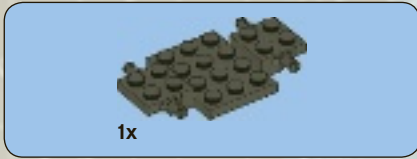
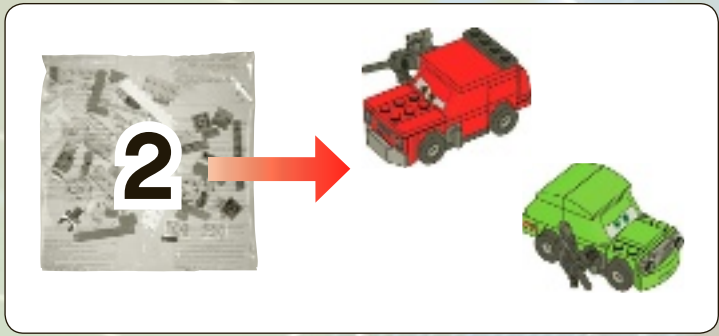

**1**



**2**

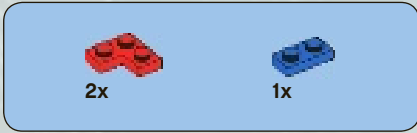
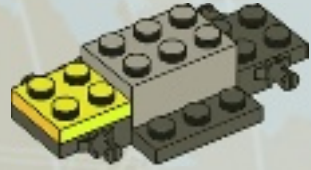

**3**

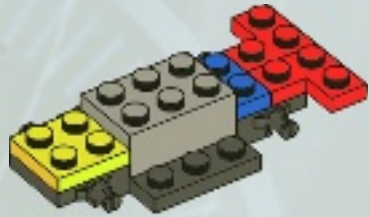



2x



2x

# 4

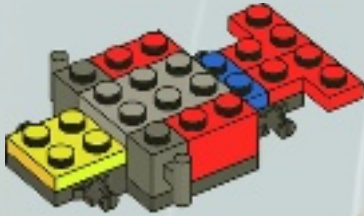

2x

# 5

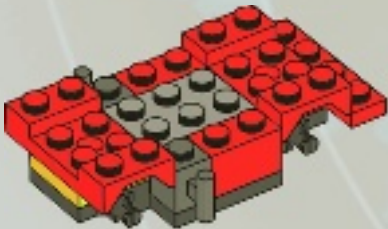

1x



2x

# 6

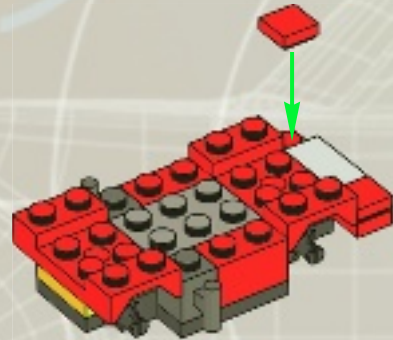





7

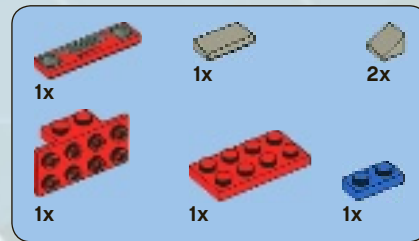
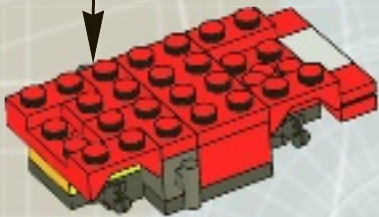
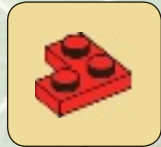

8

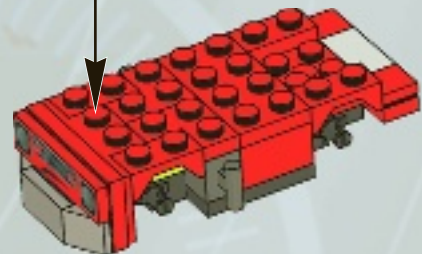
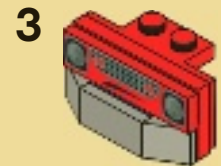
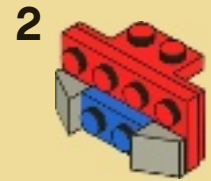
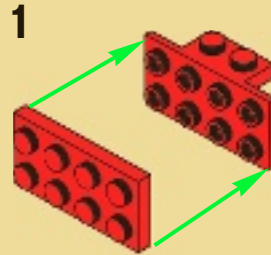

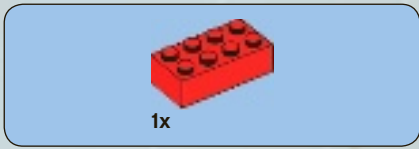

9

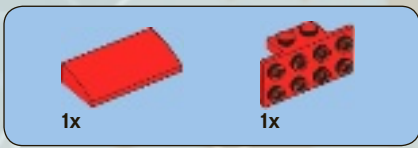
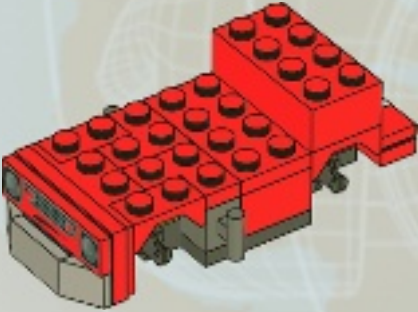

10

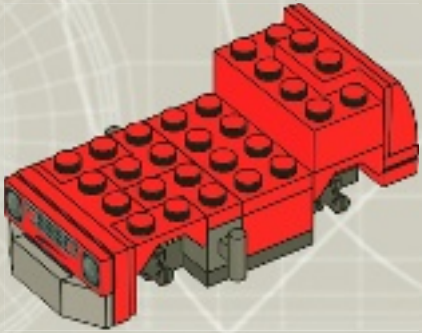
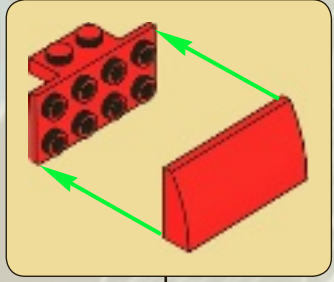



11

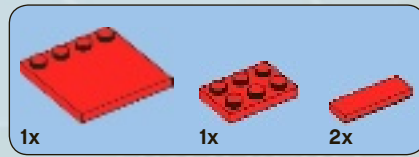
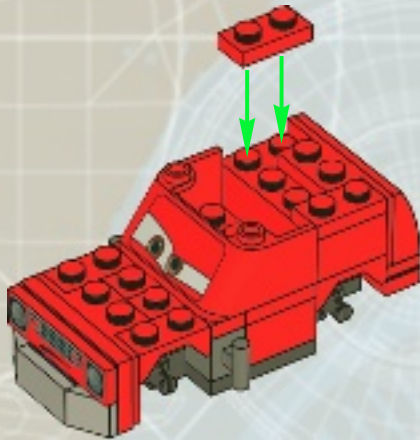

12

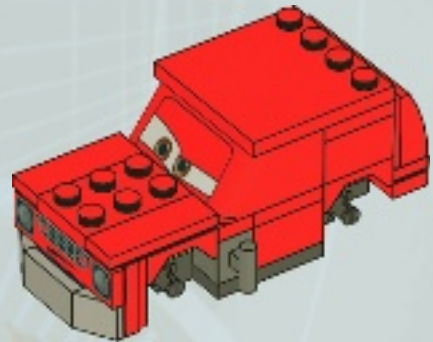



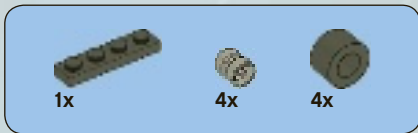

# 13

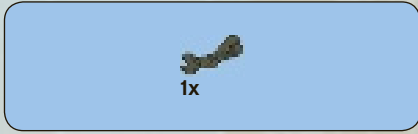
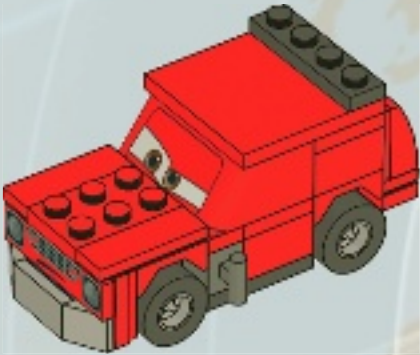

# 14



# 15

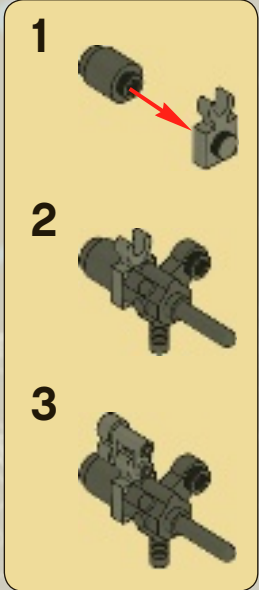



2



1

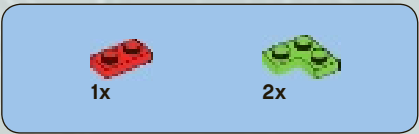
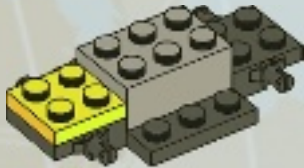

3

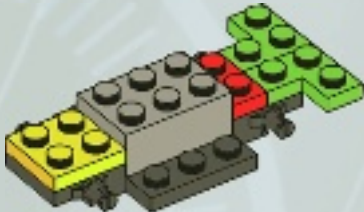



4

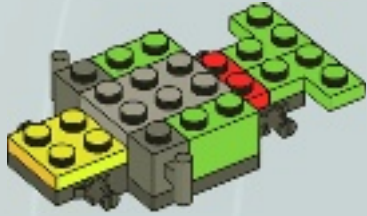

5

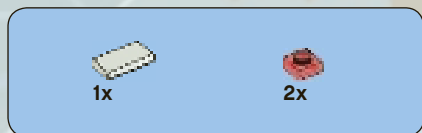

6

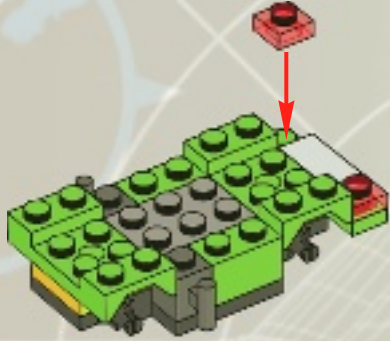

7

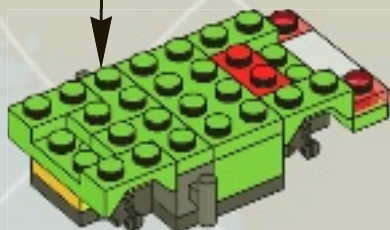





8

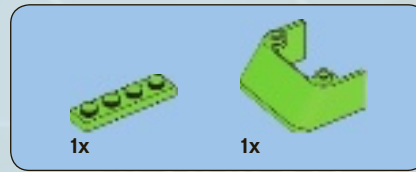
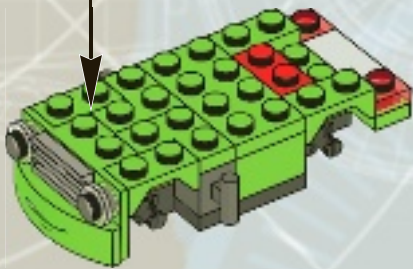
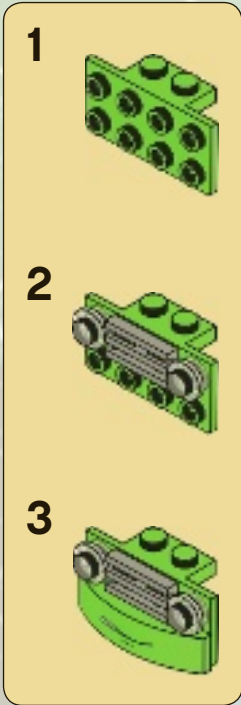

9

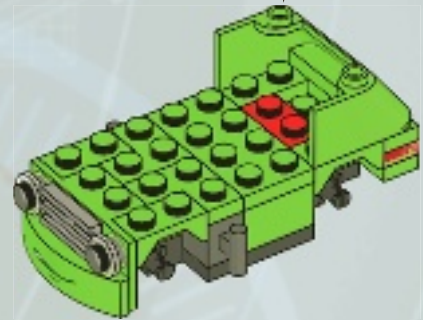
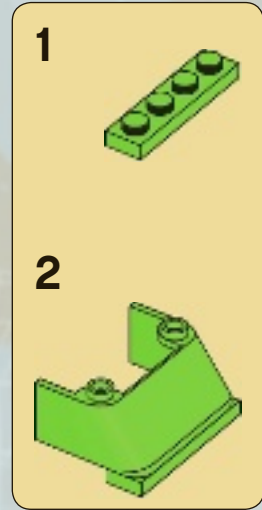



1x



1x

# 10

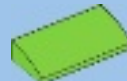
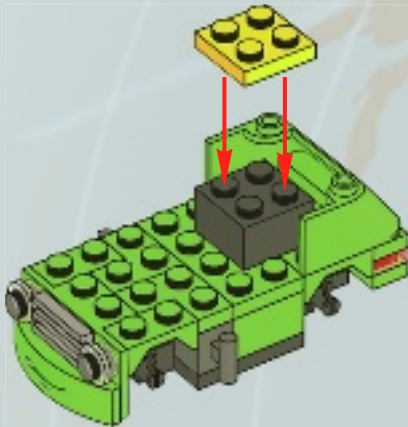

2x

# 12

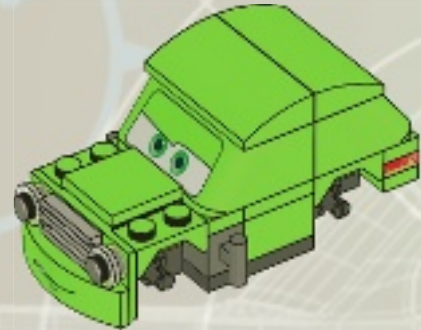

1x



1x

# 11

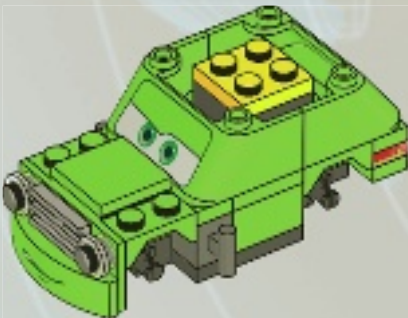

4x



4x

# 13

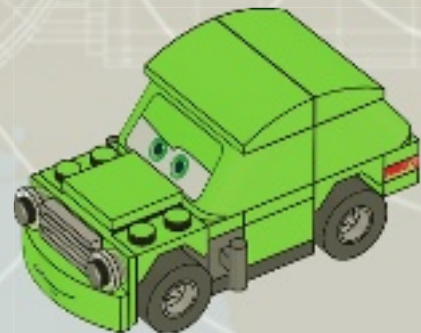



1x

# 14

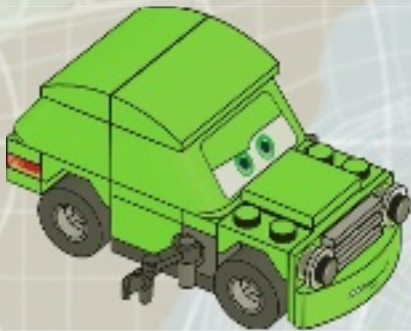

1x



1x



1x



1x

# 15

1

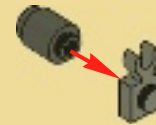

2



3

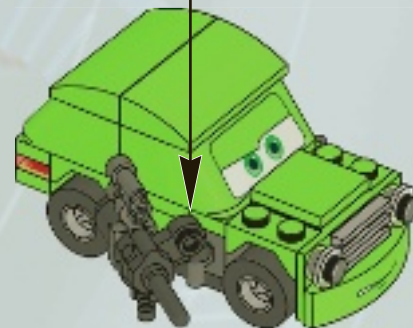

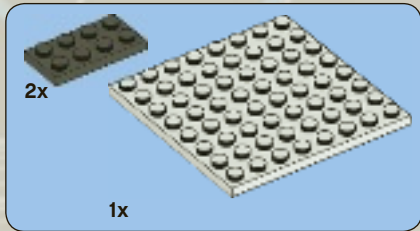

1

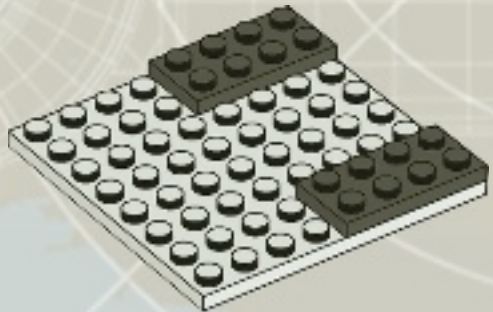





1x



2x

2

target  
acquired

waypoint 2

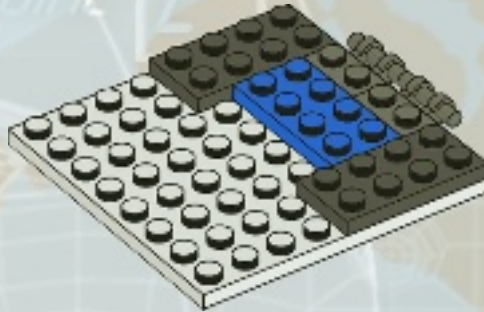

2x

3



laypoint 1

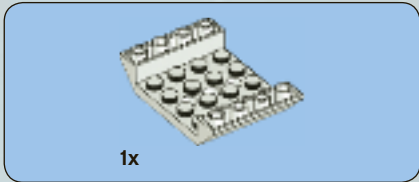

4

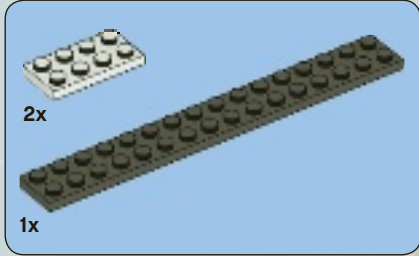
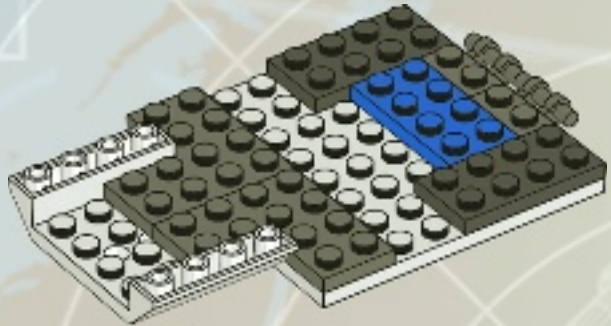

5

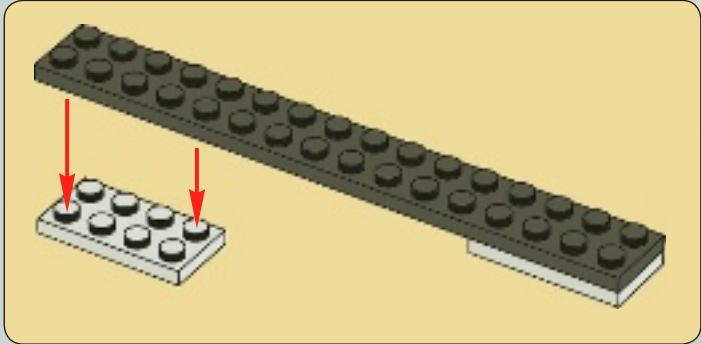

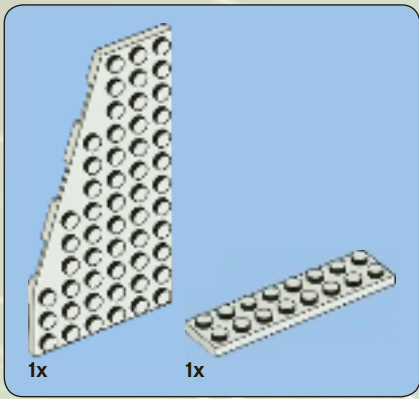

6

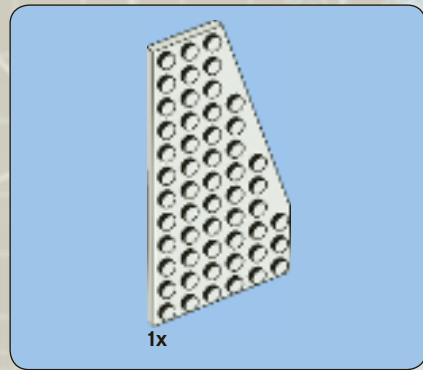
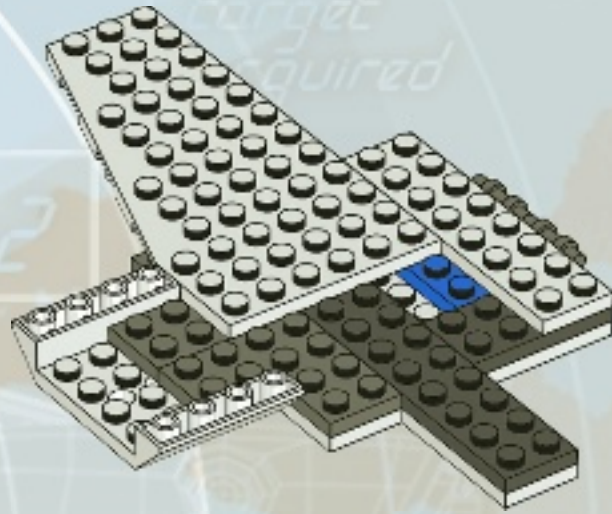

7

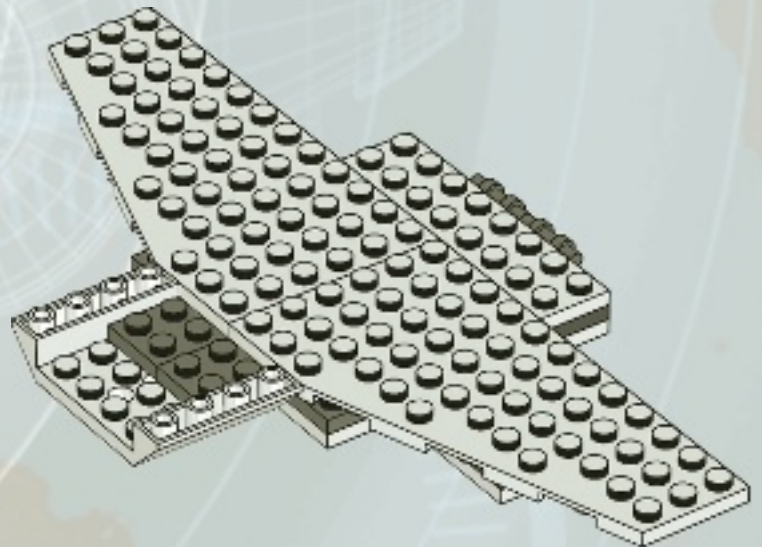



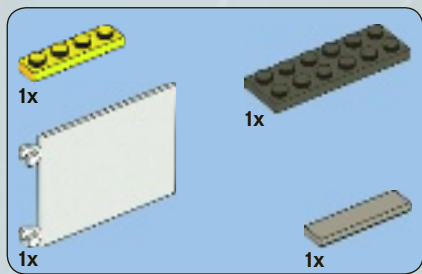

8

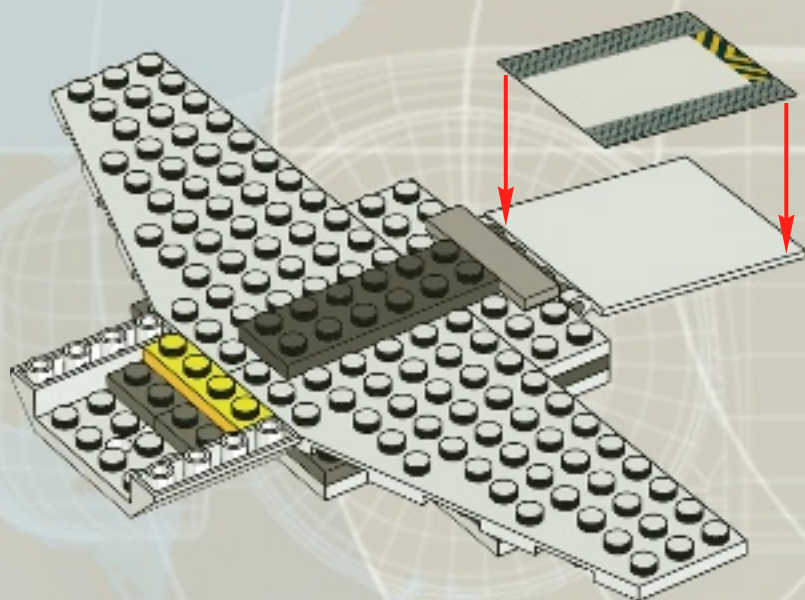



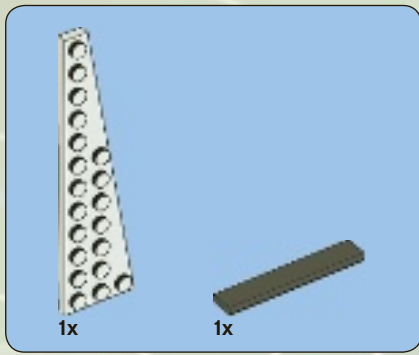

9

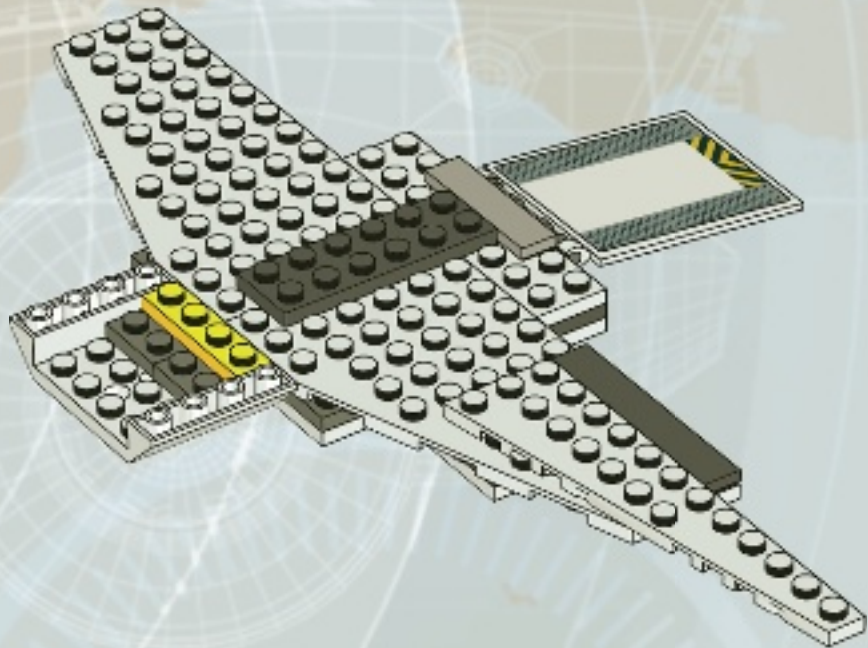

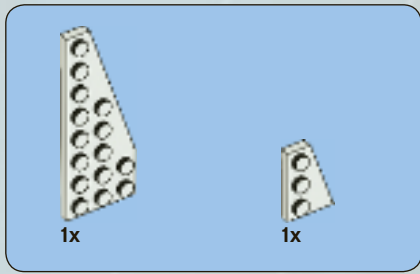

10

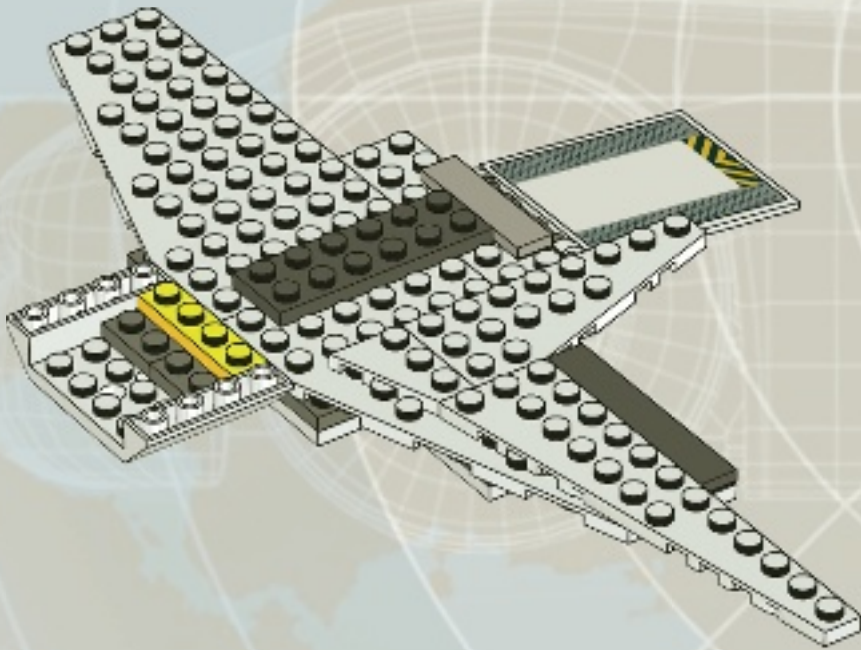

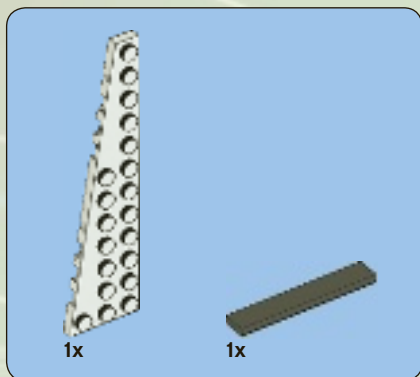

11

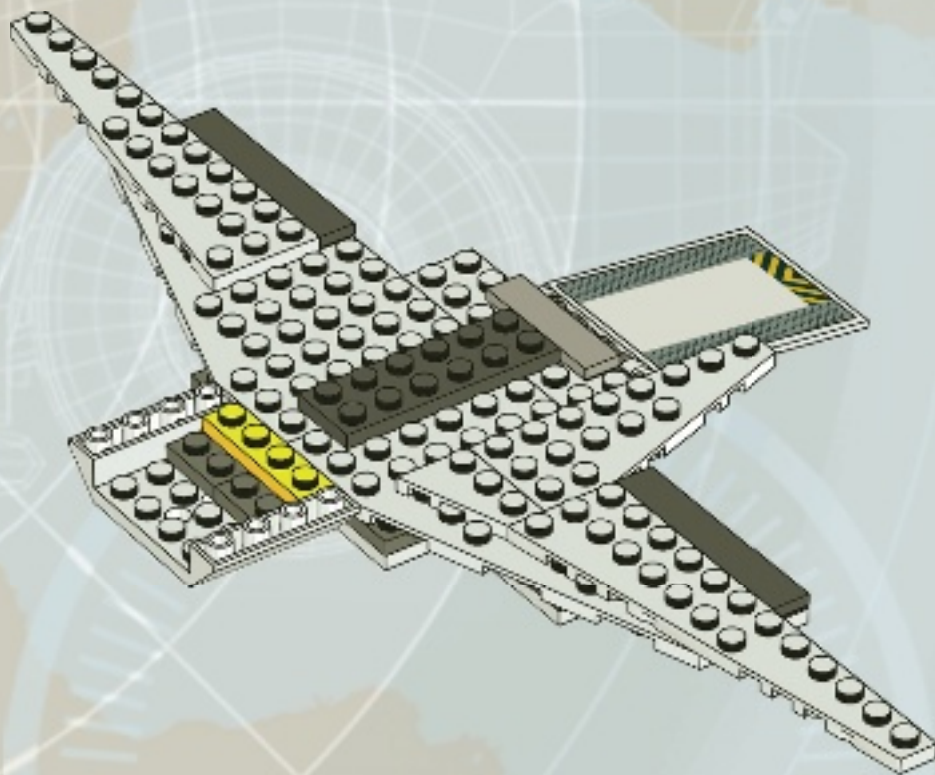

aypoint 1

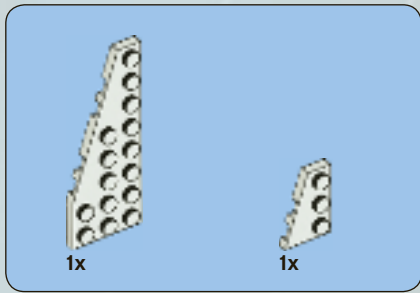

12

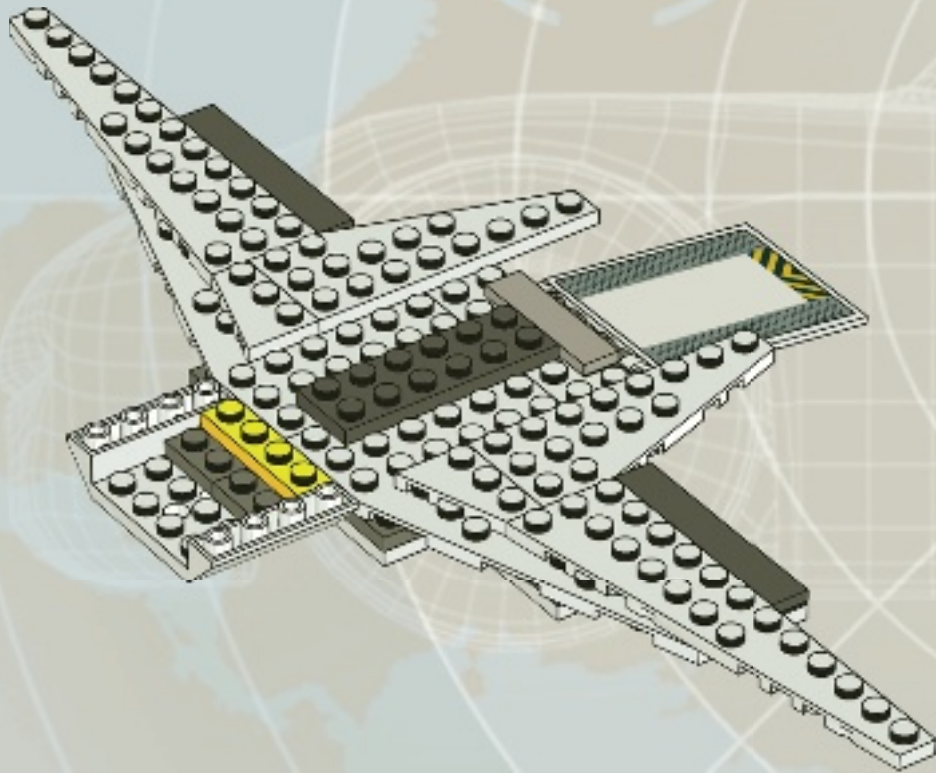



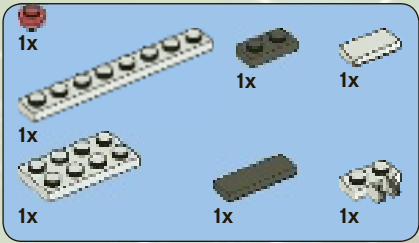
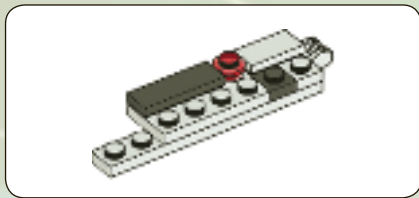

# 13

1



2



3



4

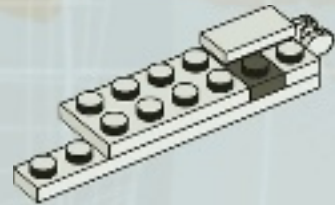

5

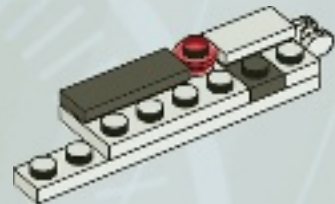

waypoint

1

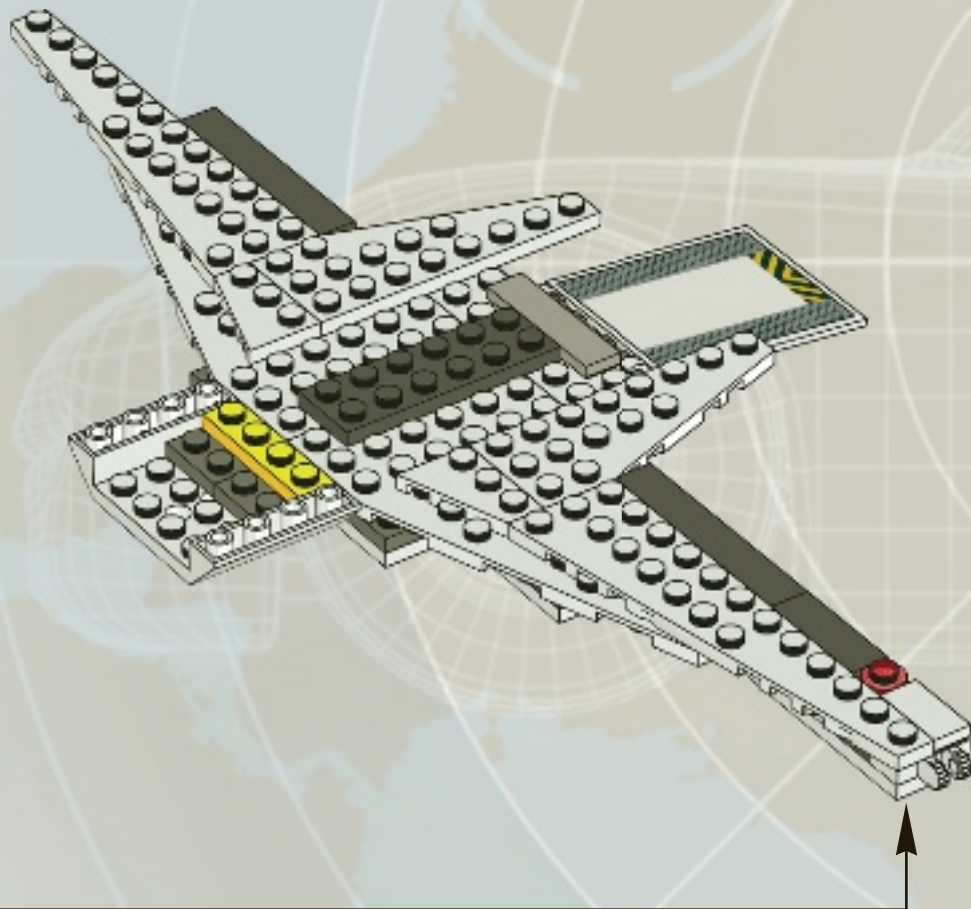

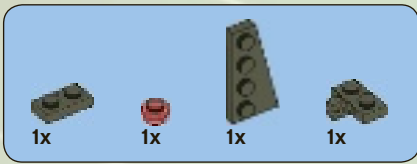

# 14

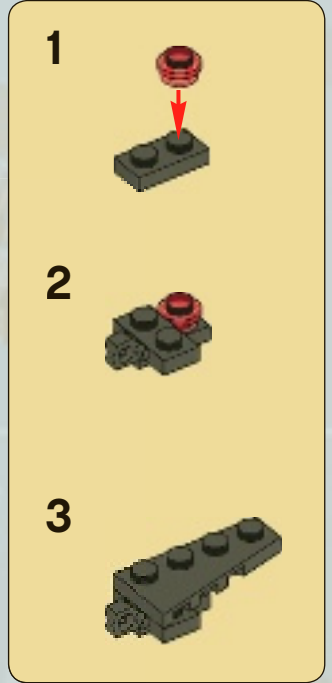
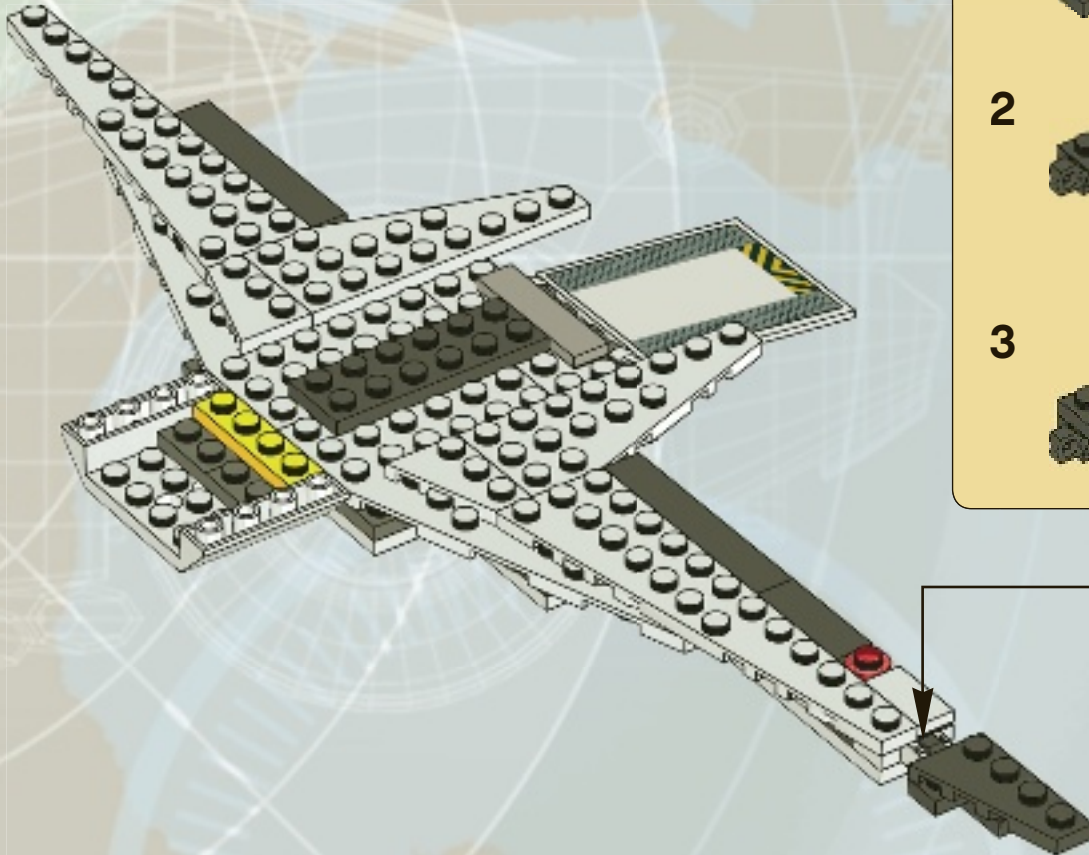

aypoint

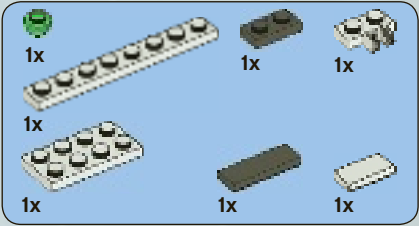
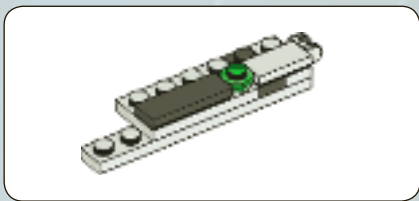

15

1



2

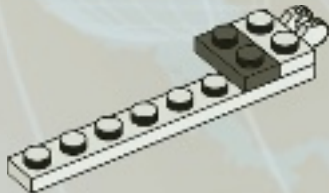

3



4



5

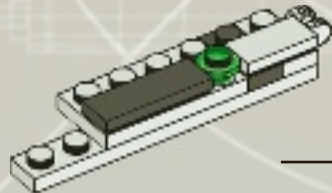



target  
acquired

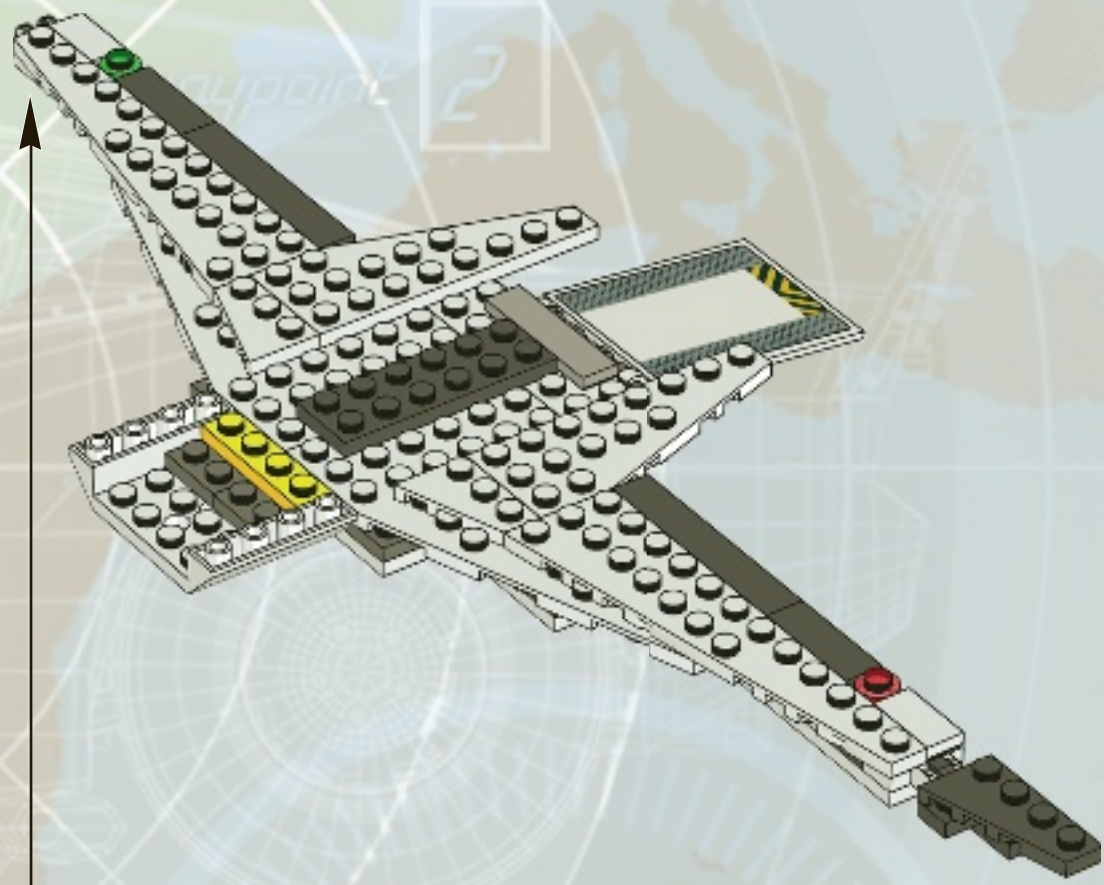



# 16

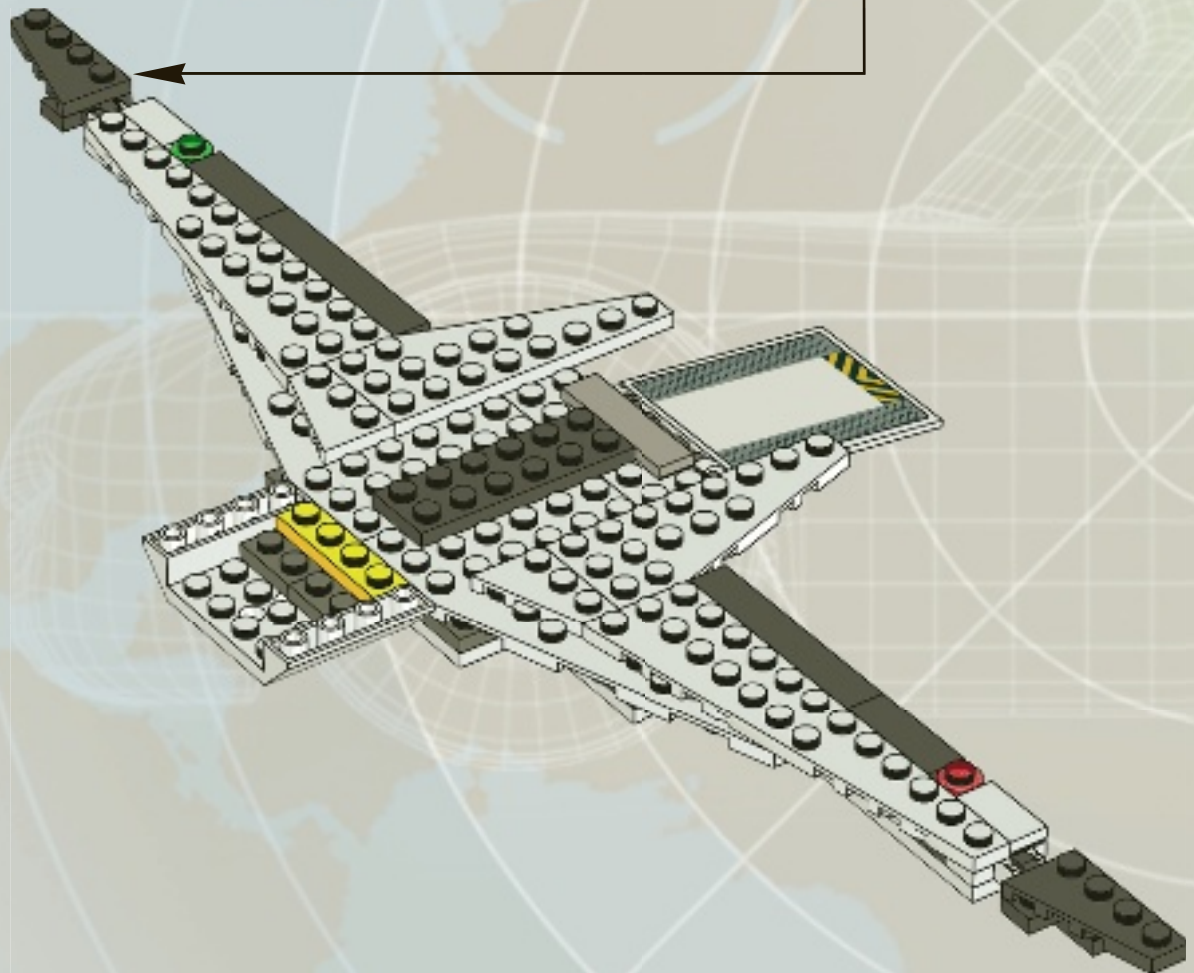



2x

17

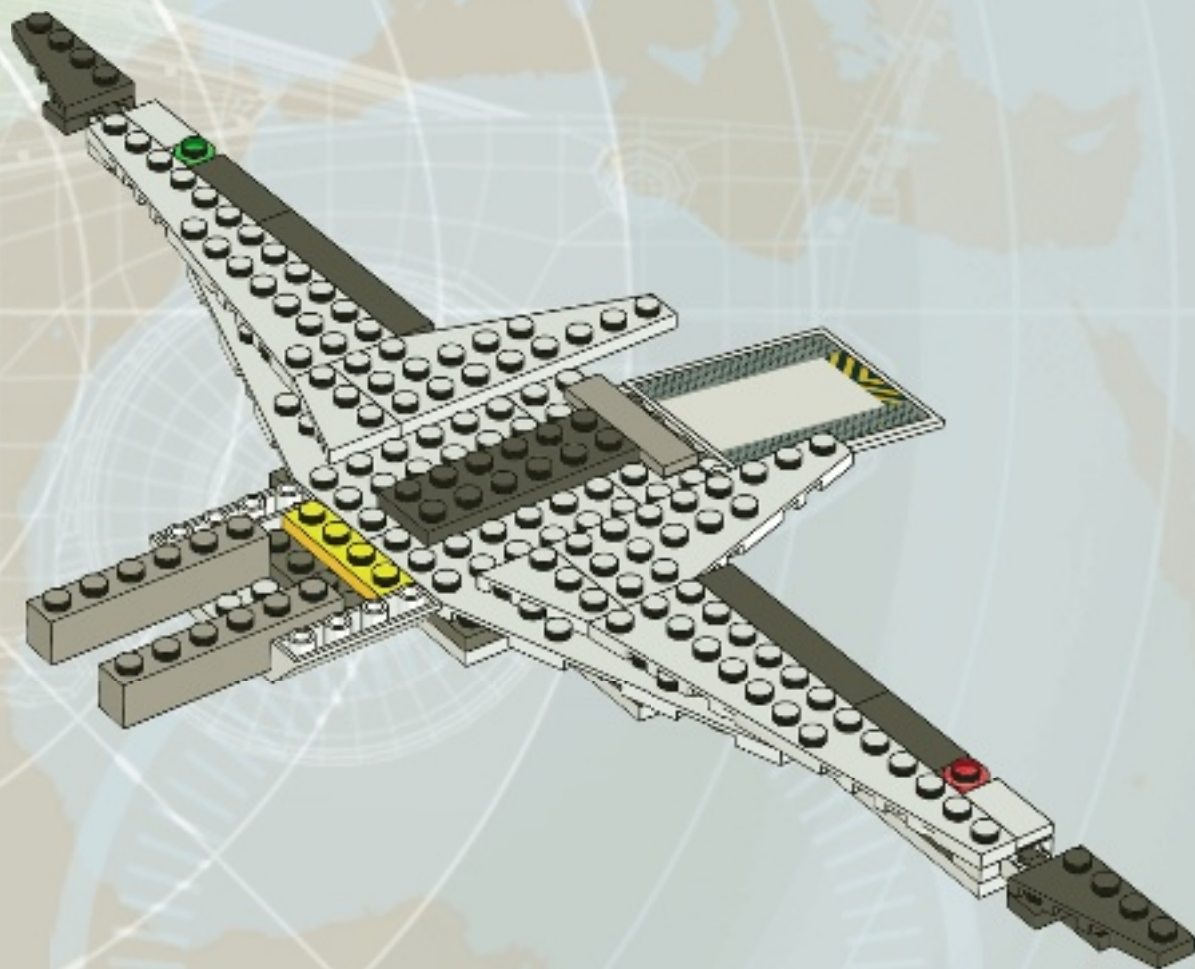



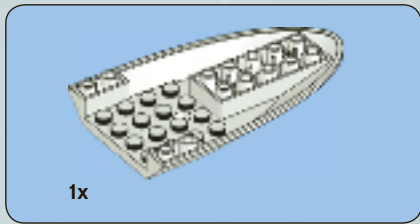

18

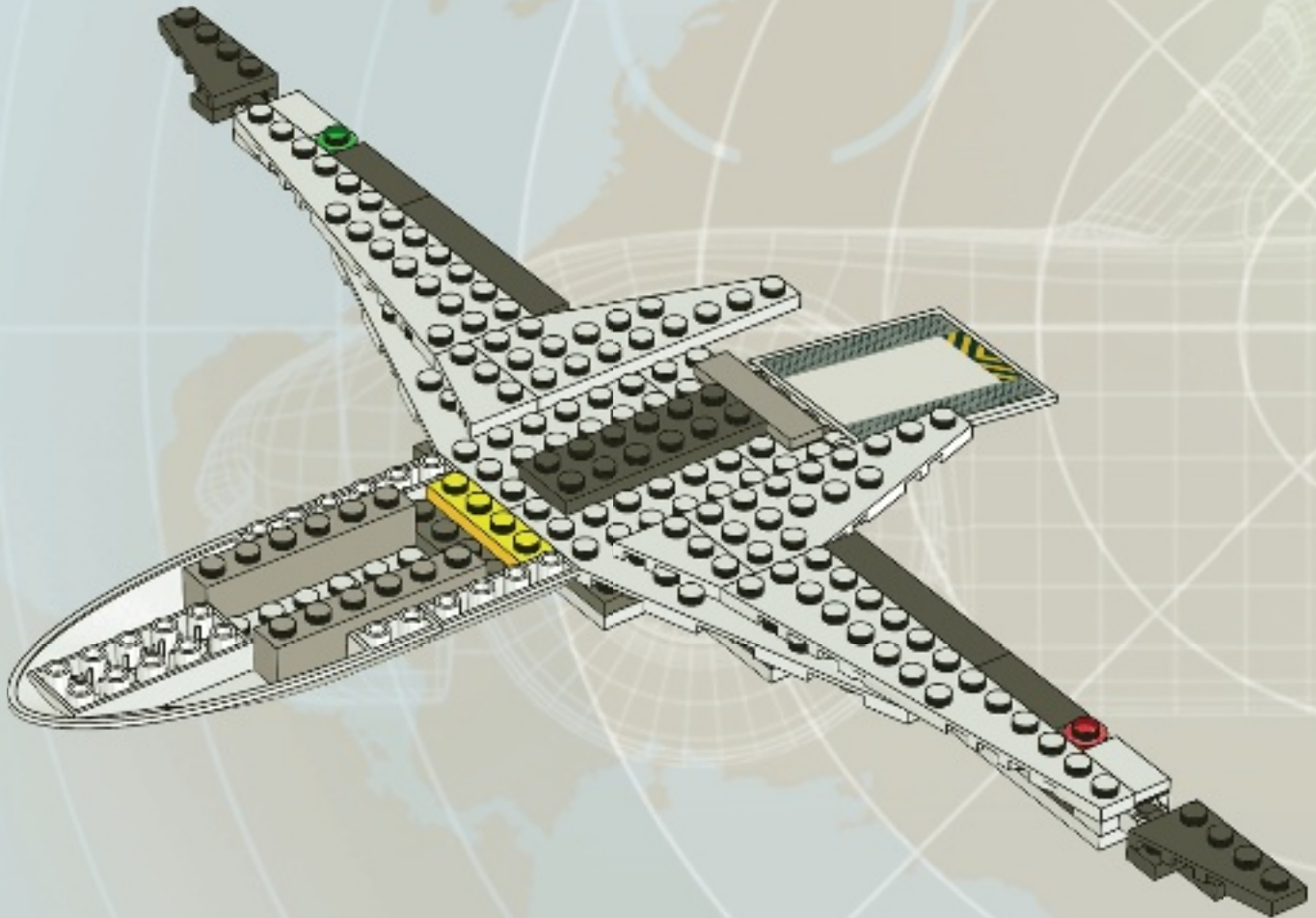





19

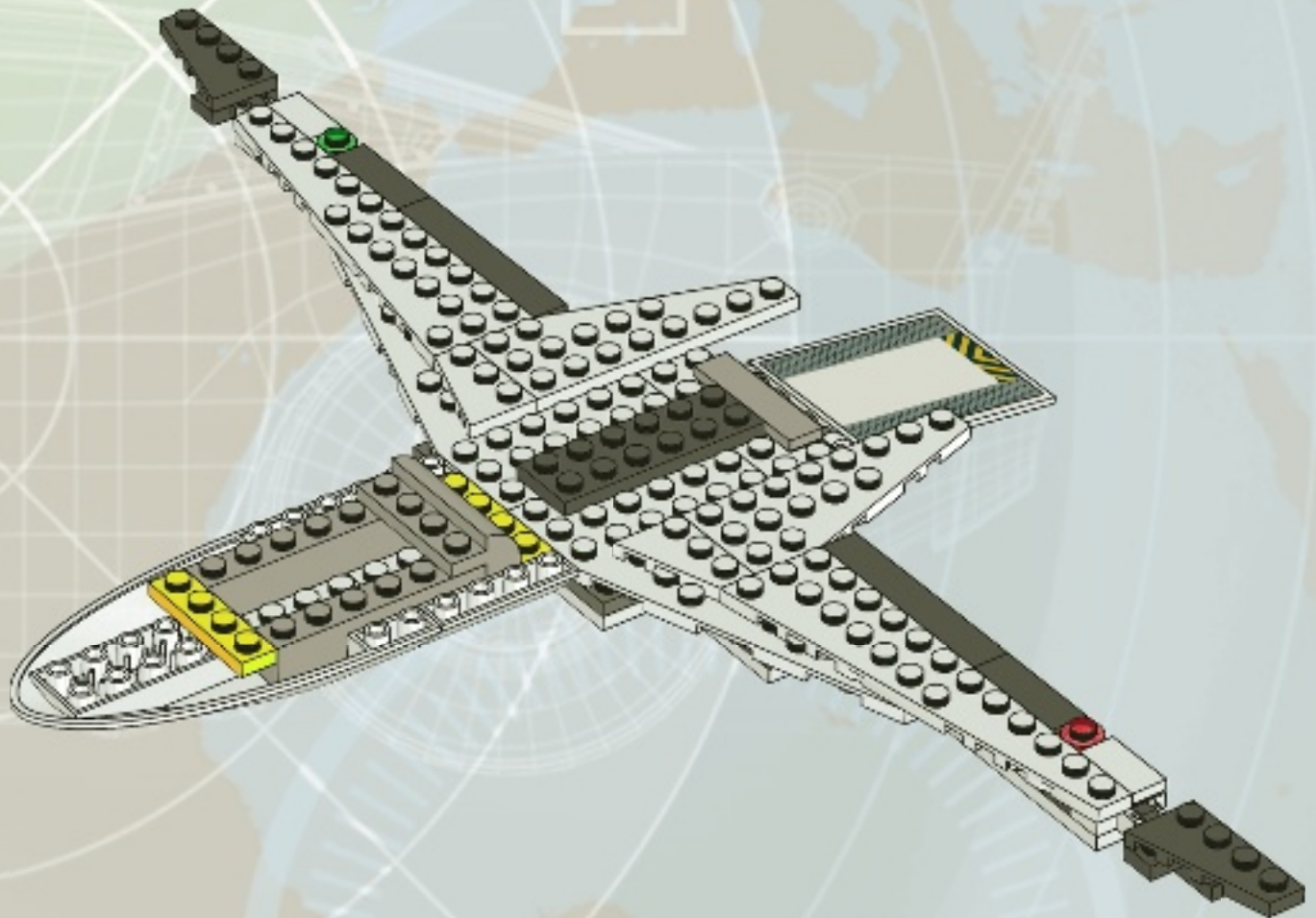

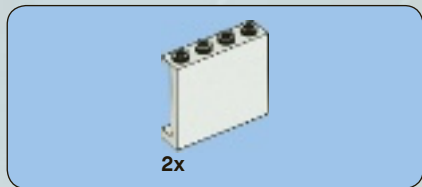

20

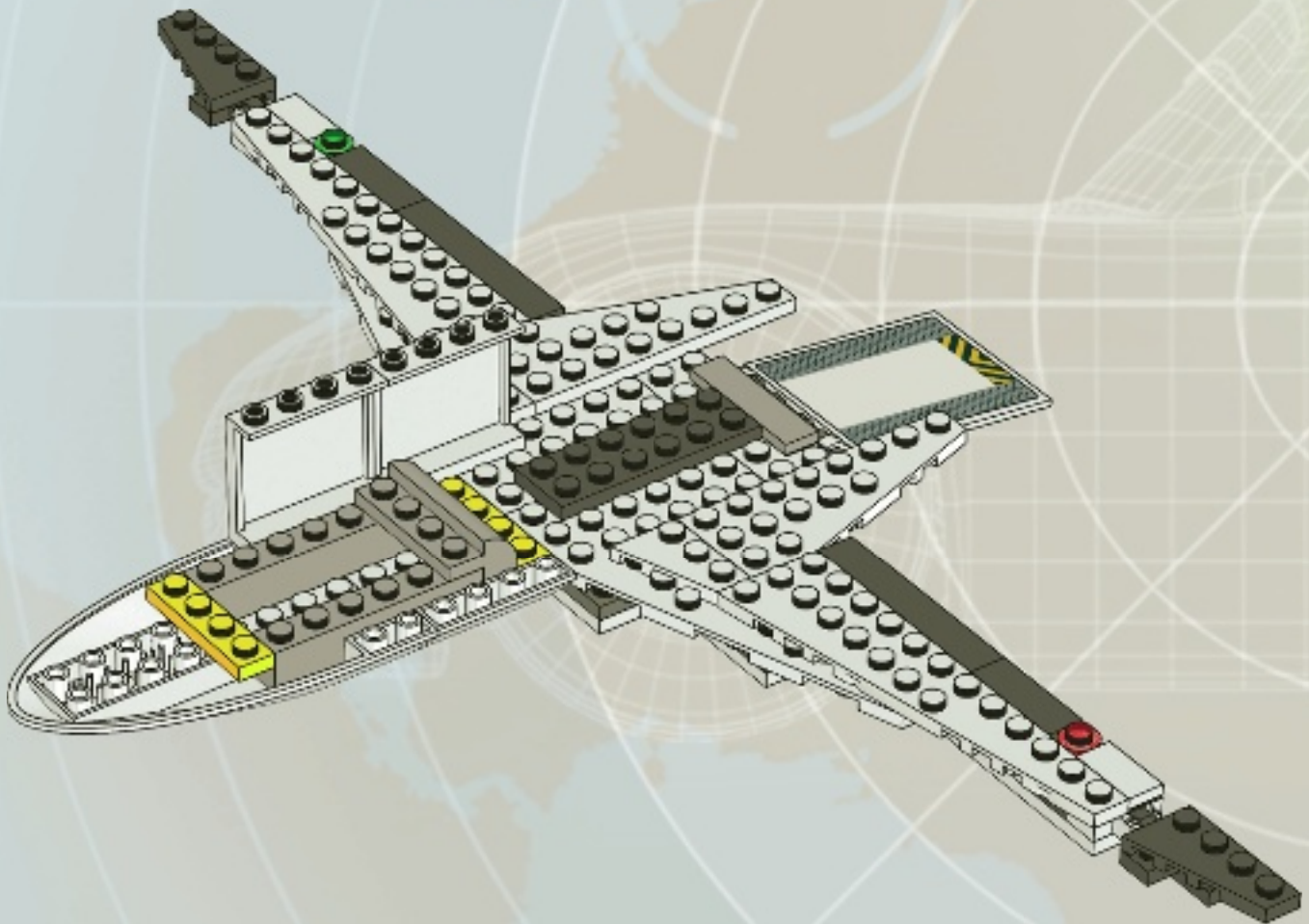



21

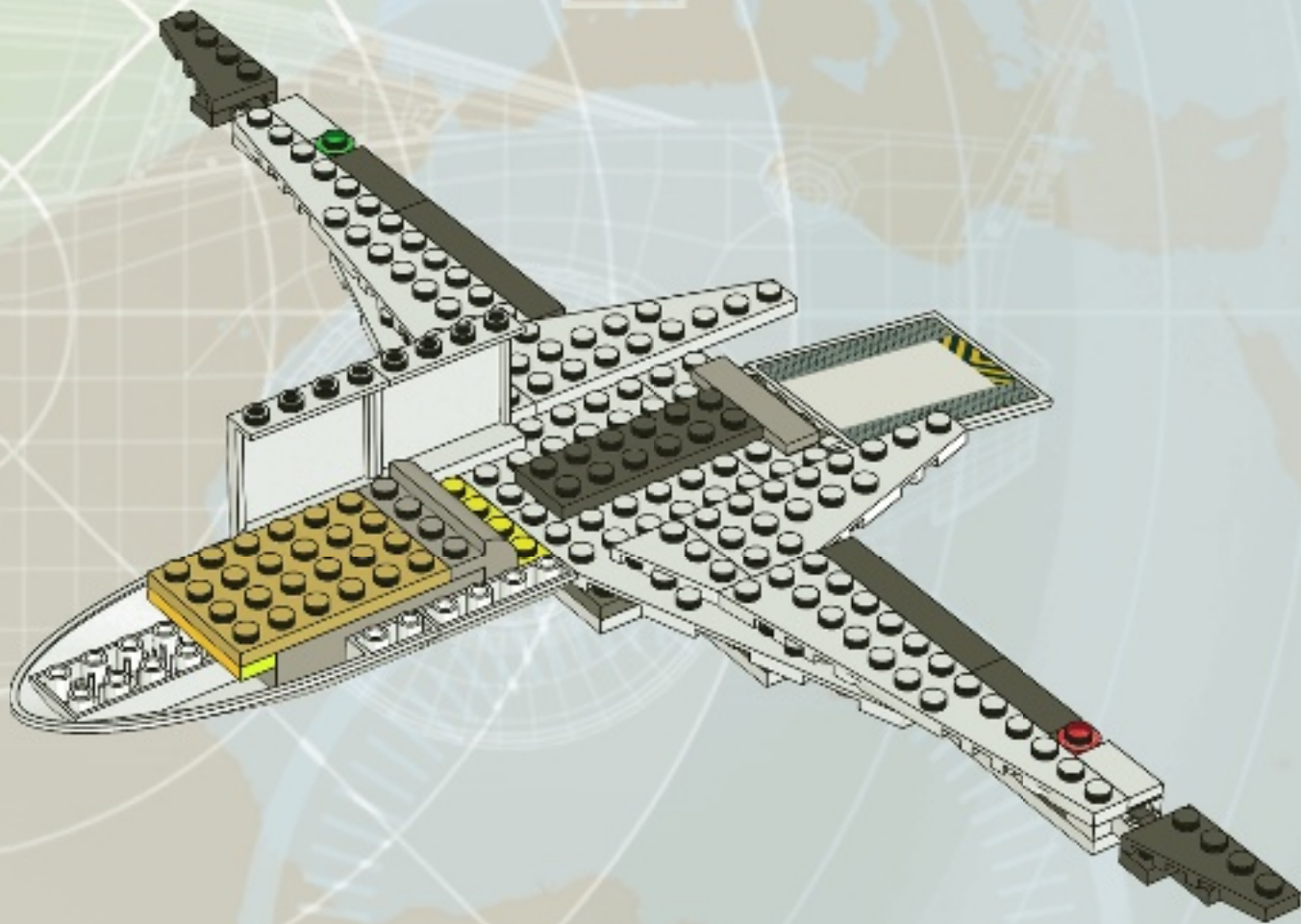



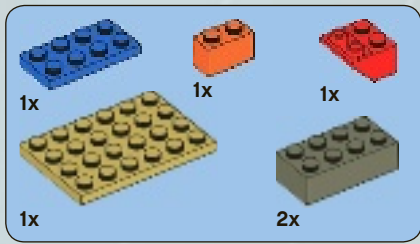

# 22

1

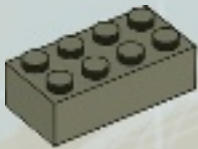

2

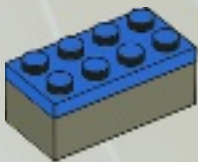

3



4

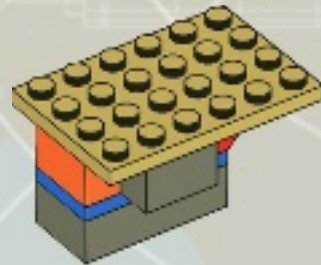



target  
acquired

waypoint 2

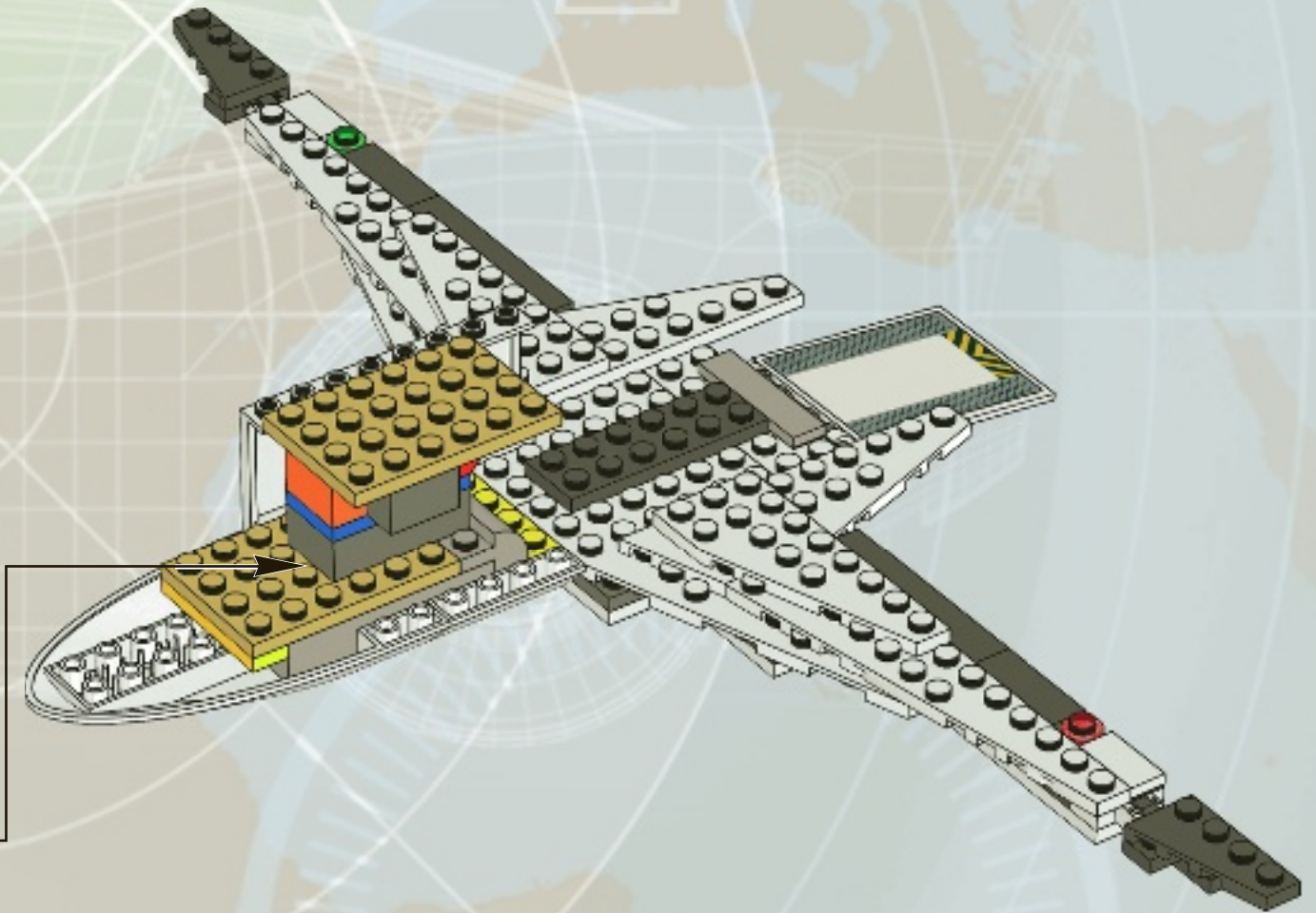



4

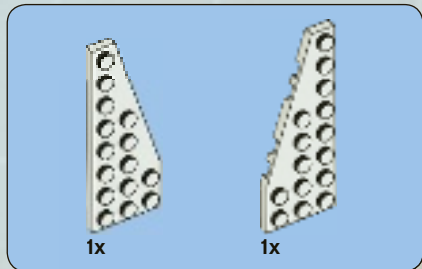

23

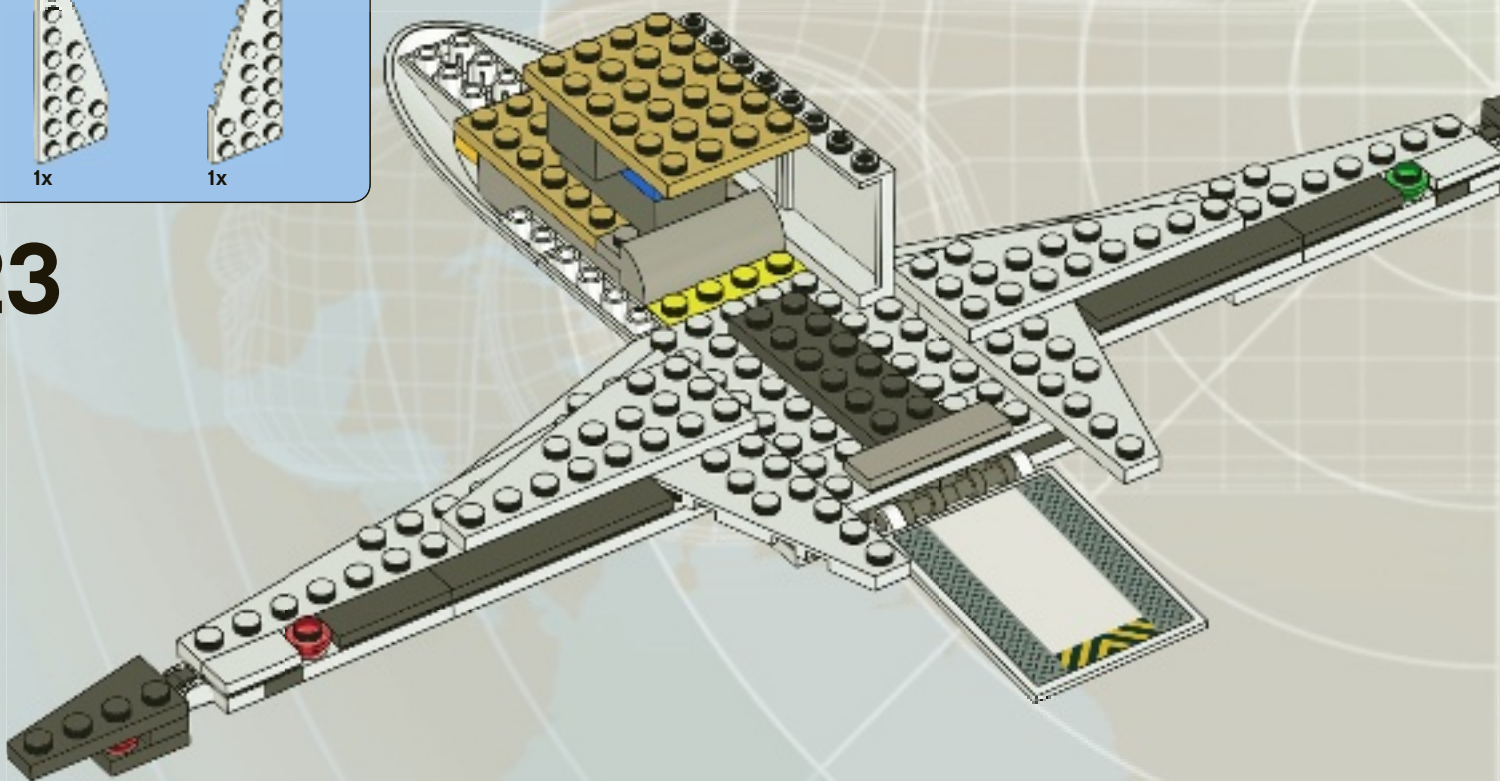

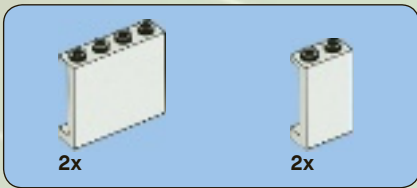

24

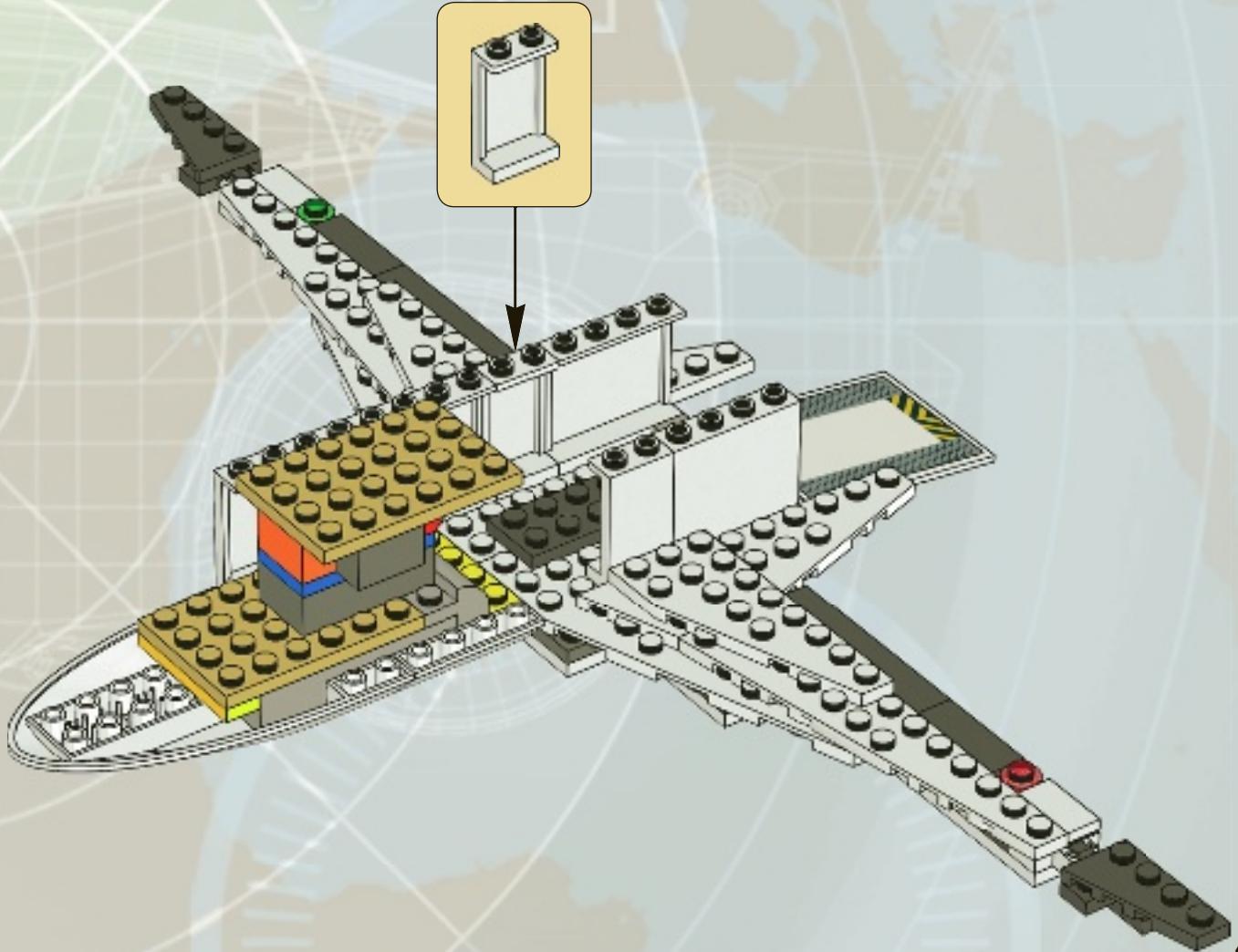





25

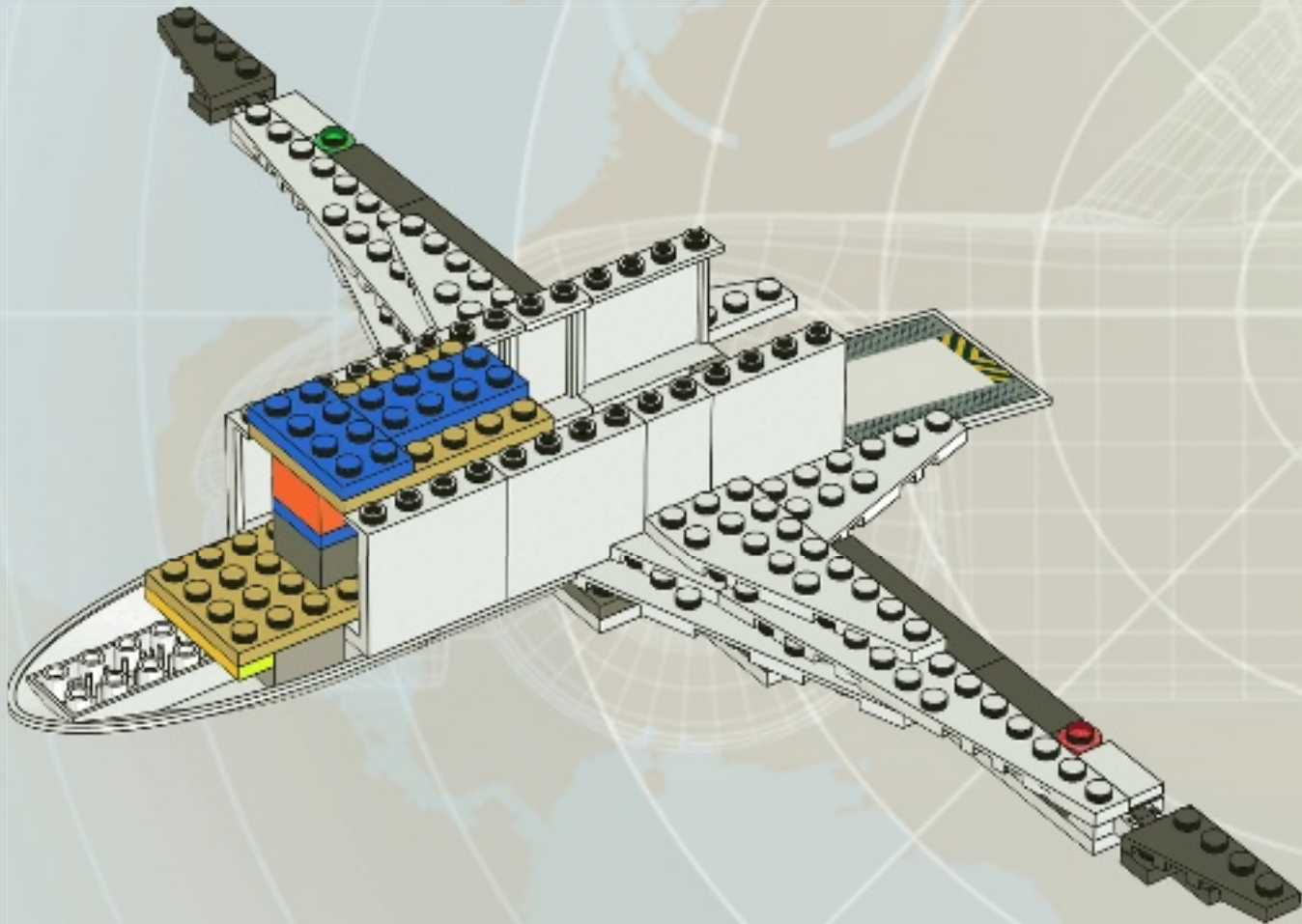



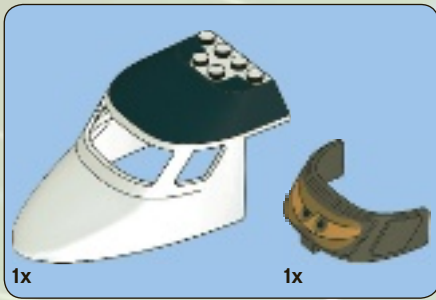

26

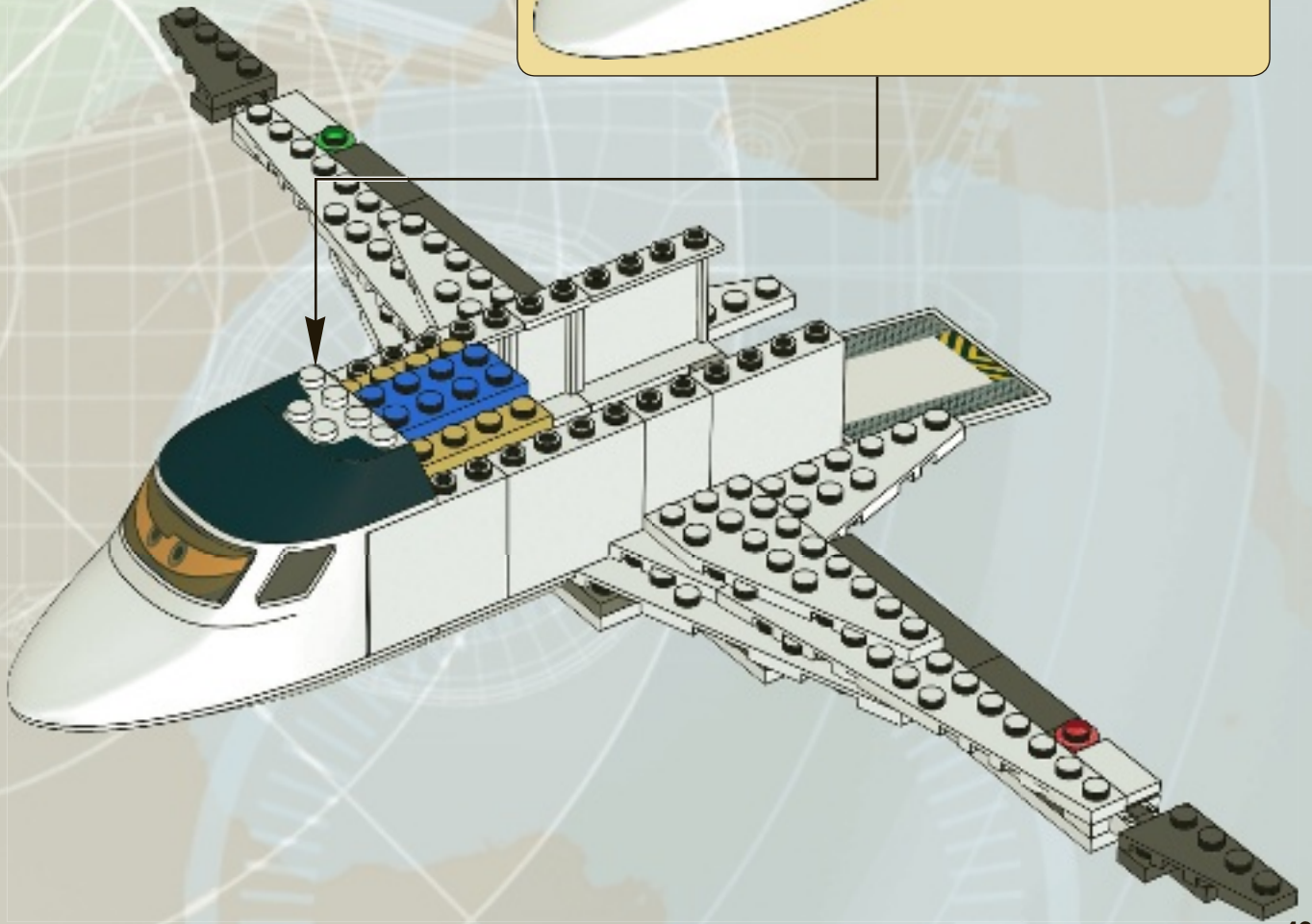
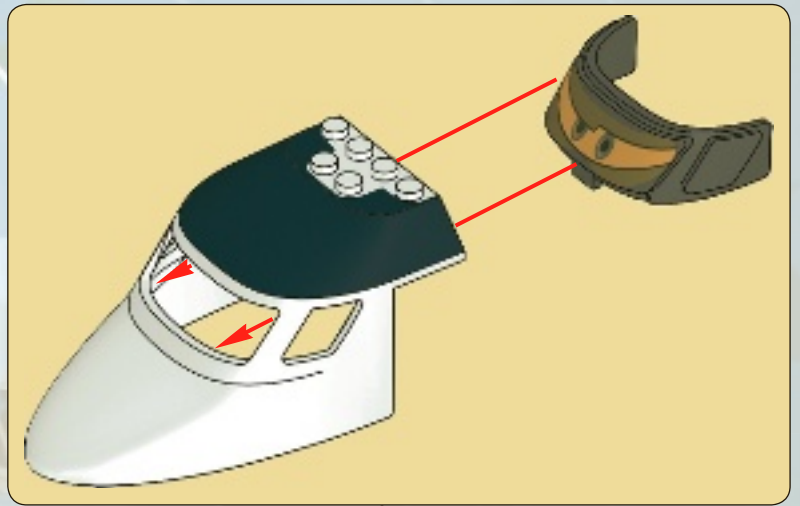

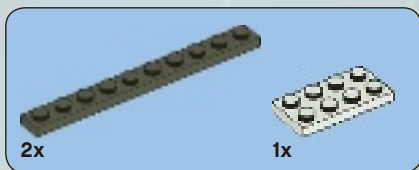

27

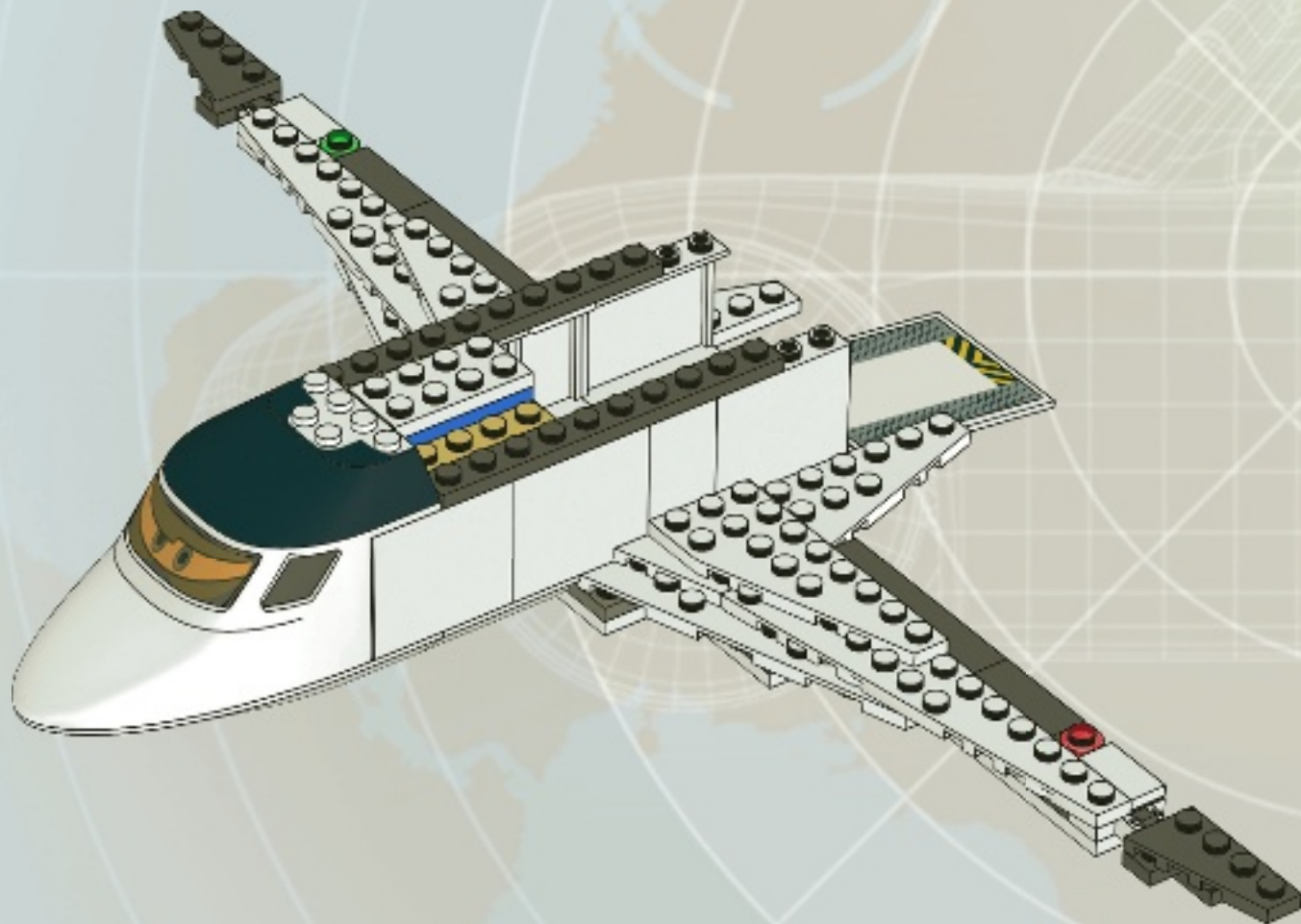

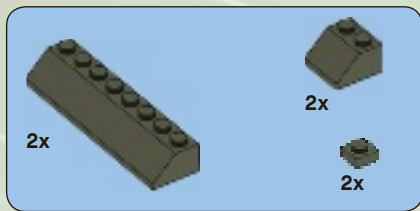

28

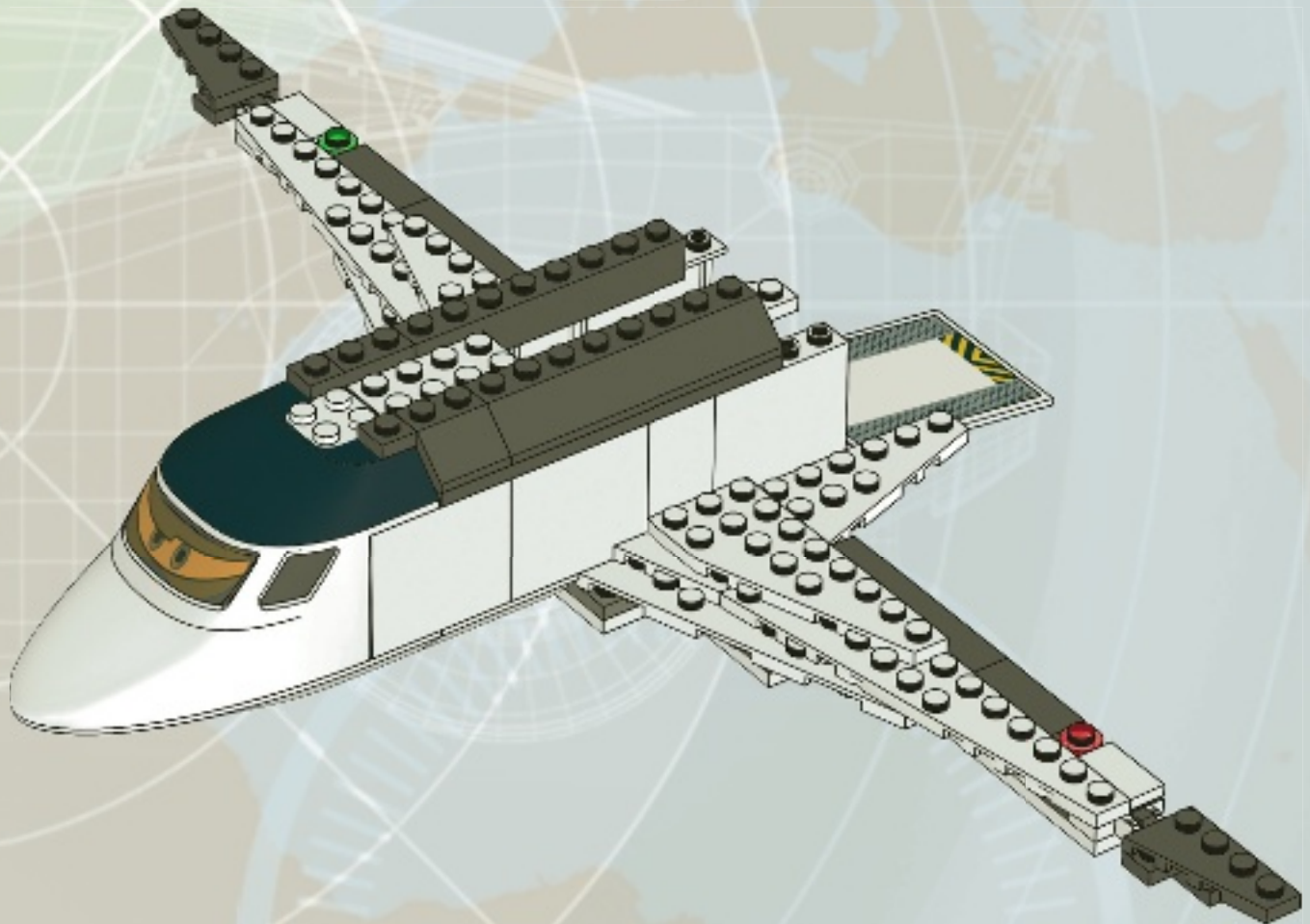



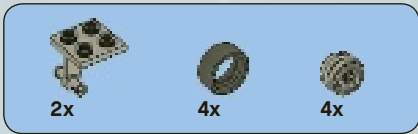

29

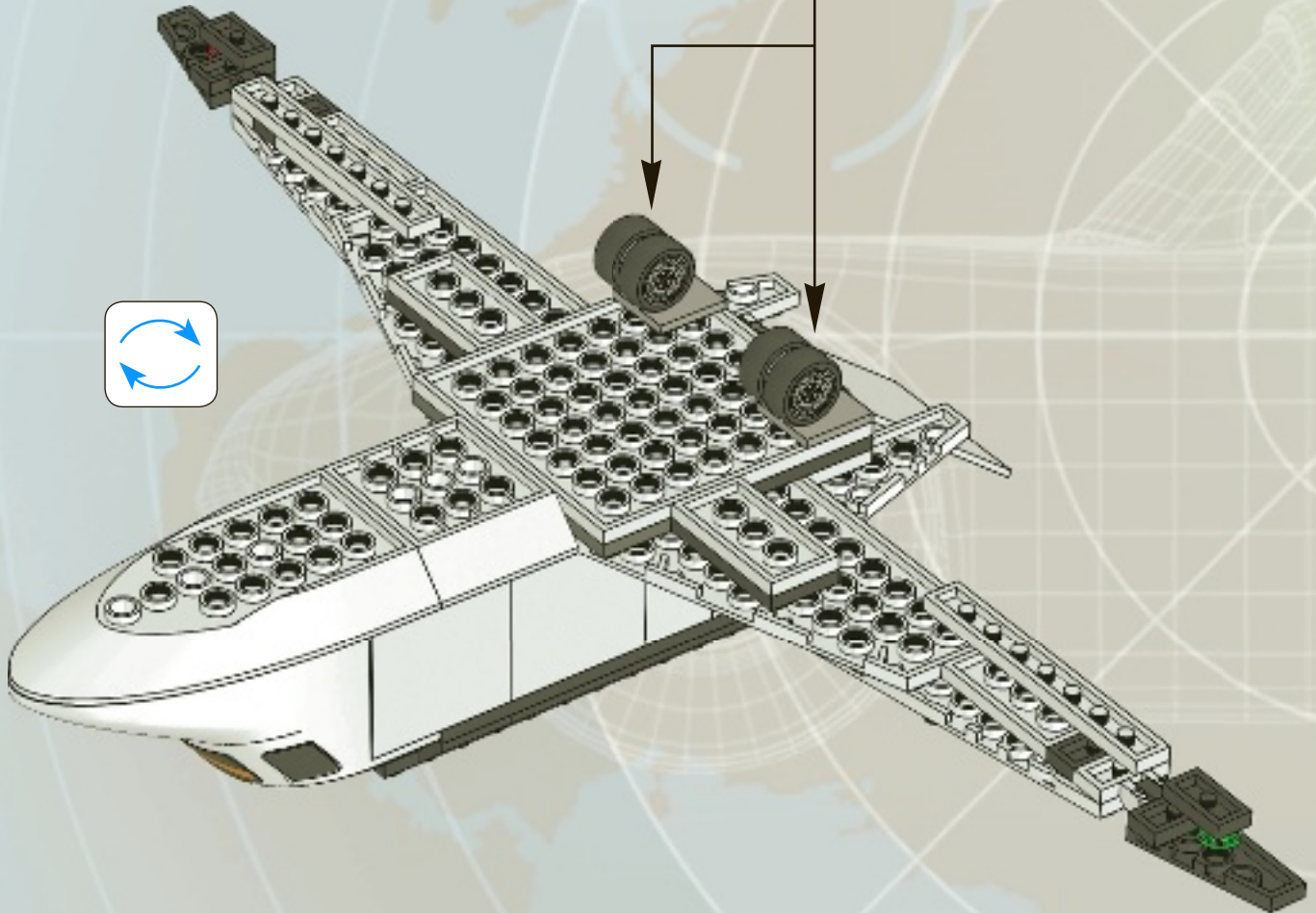
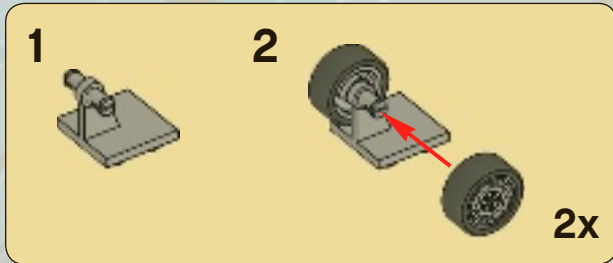





2x

# 30



2x

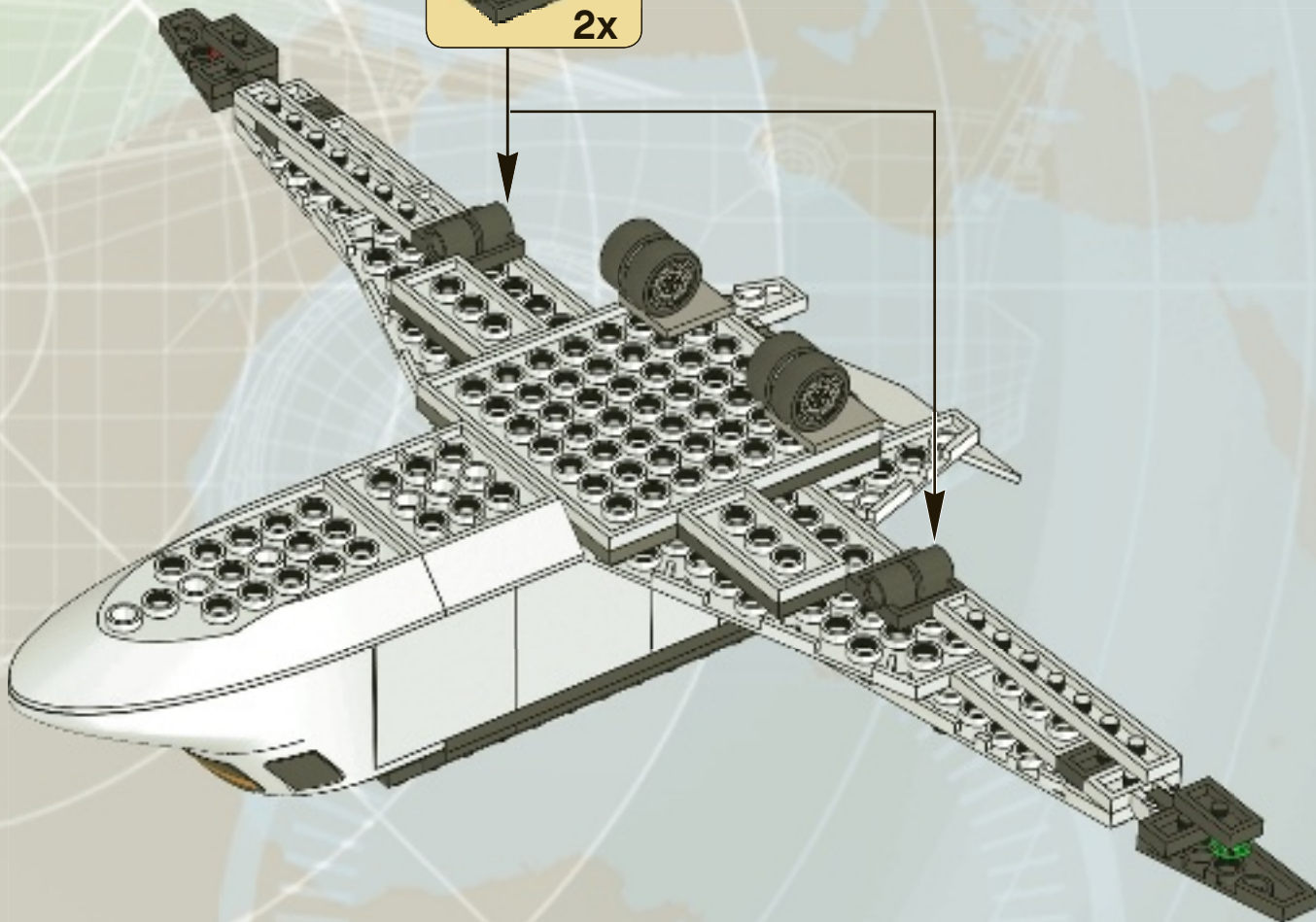

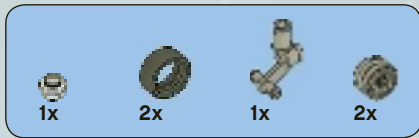

# 31

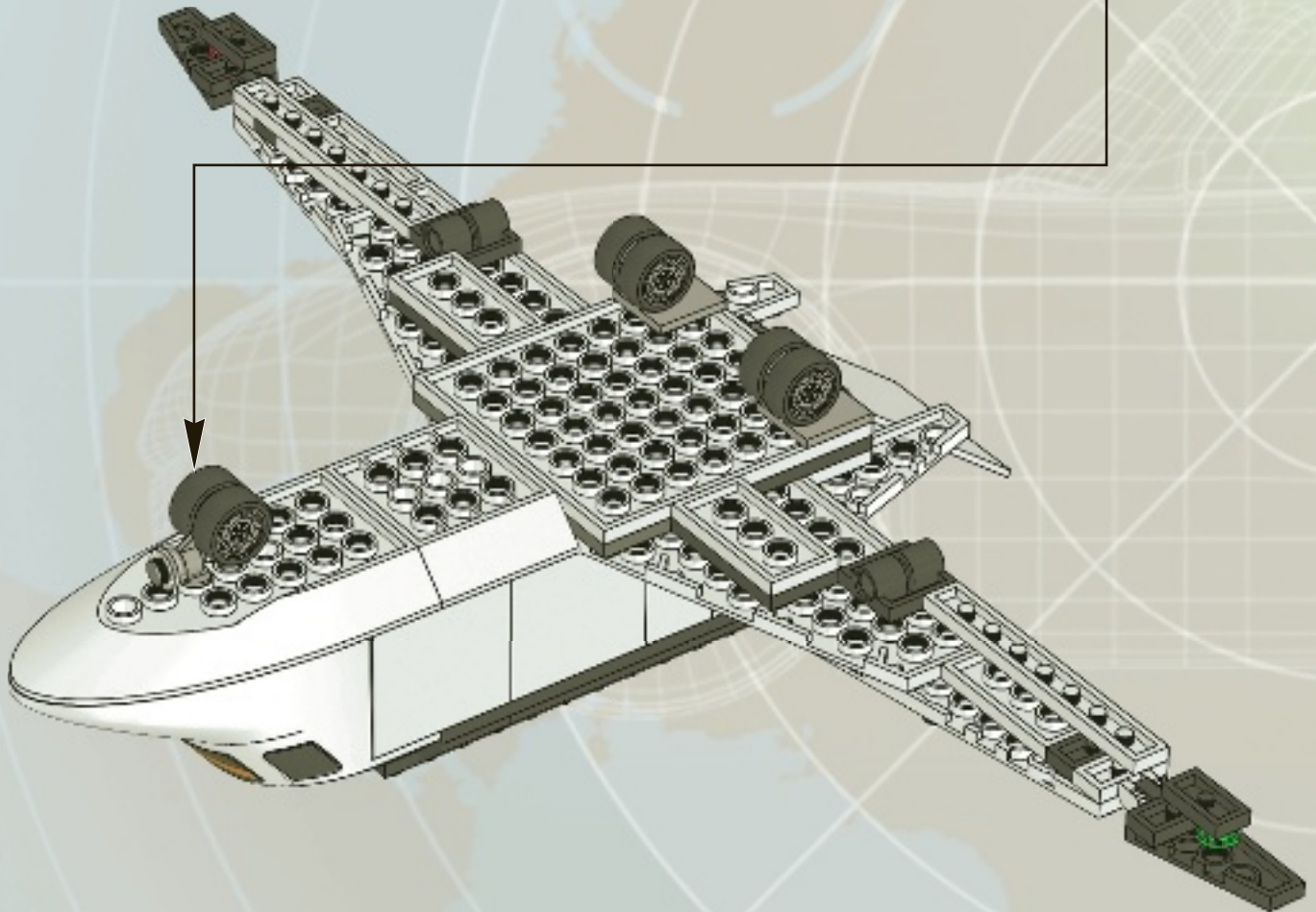
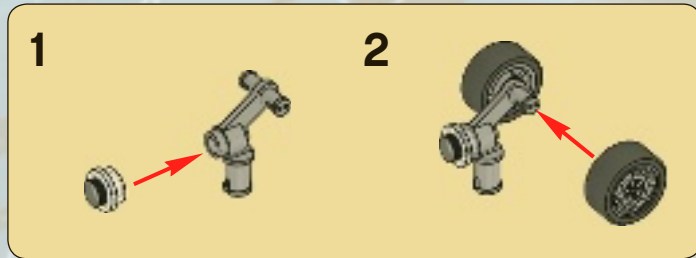



2x



2x

# 32

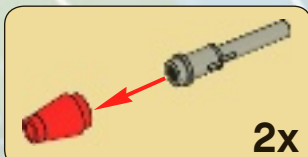

2x

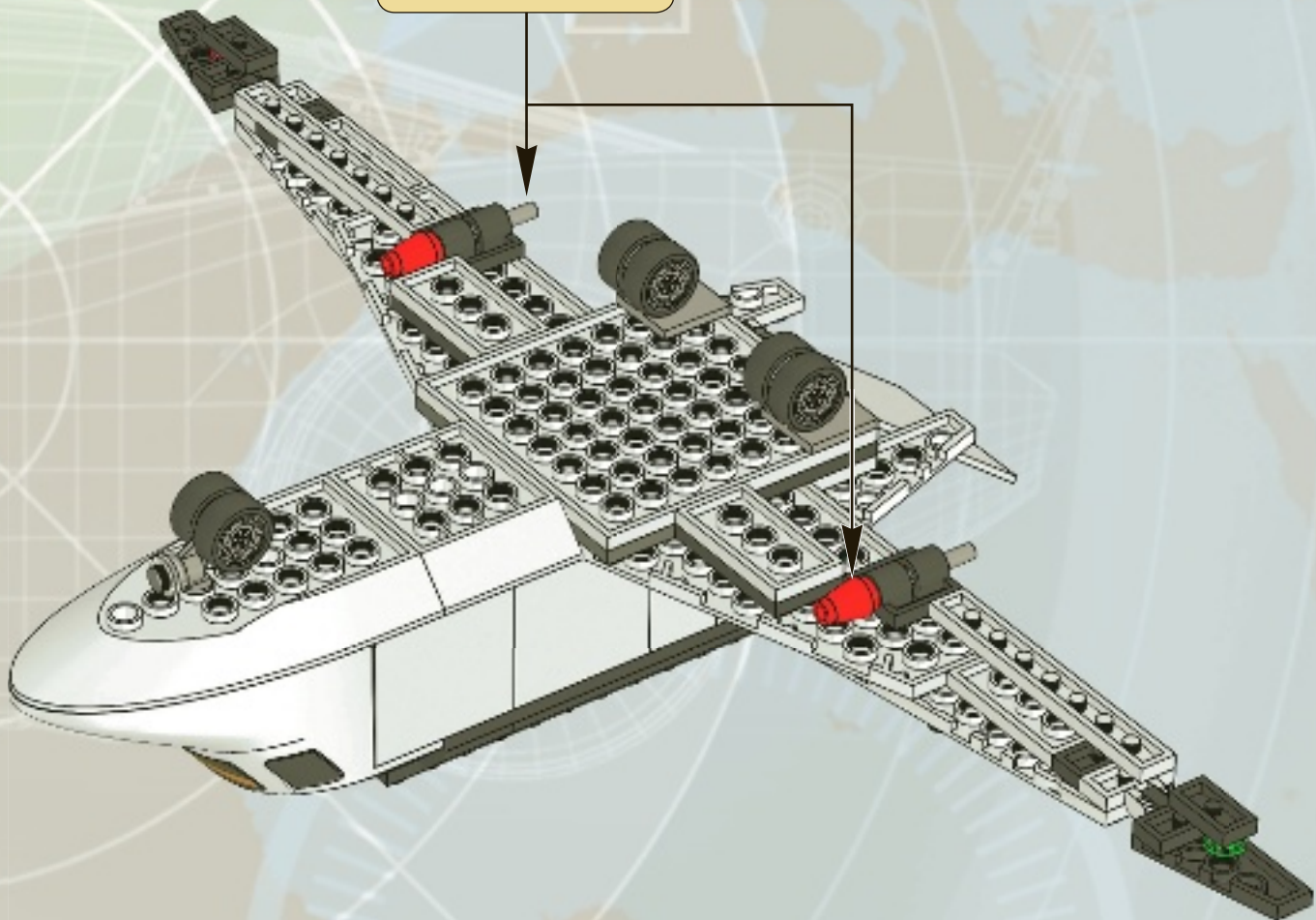



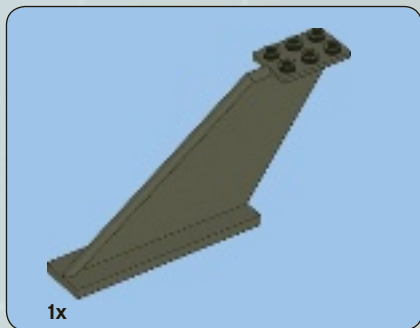

1



2





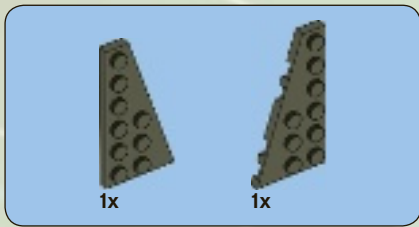

3



4

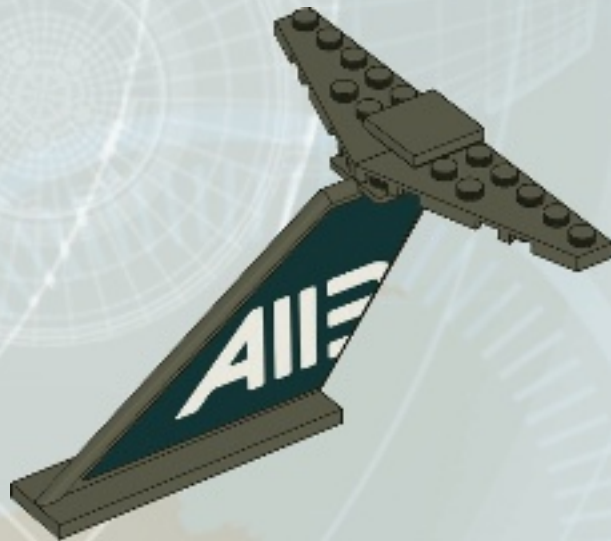

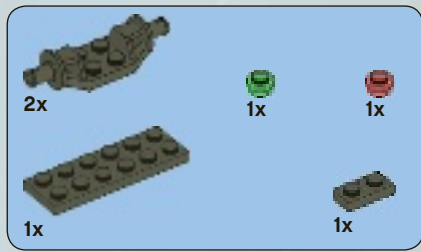

5

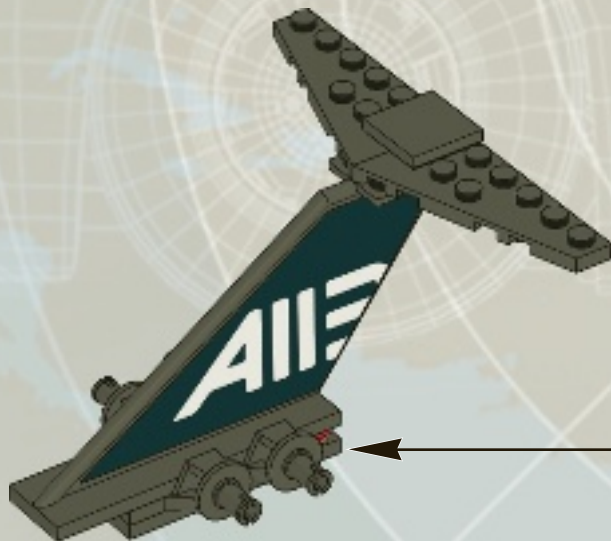
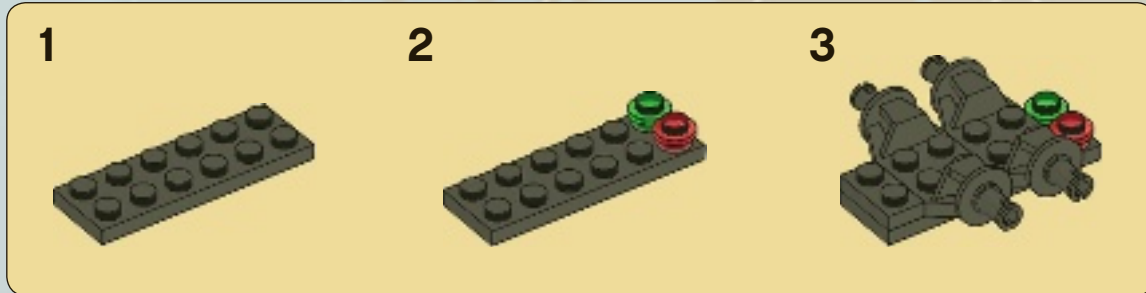

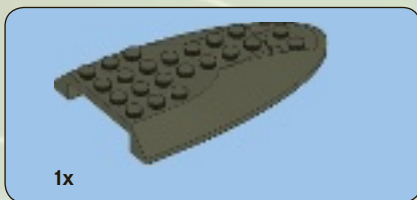

6

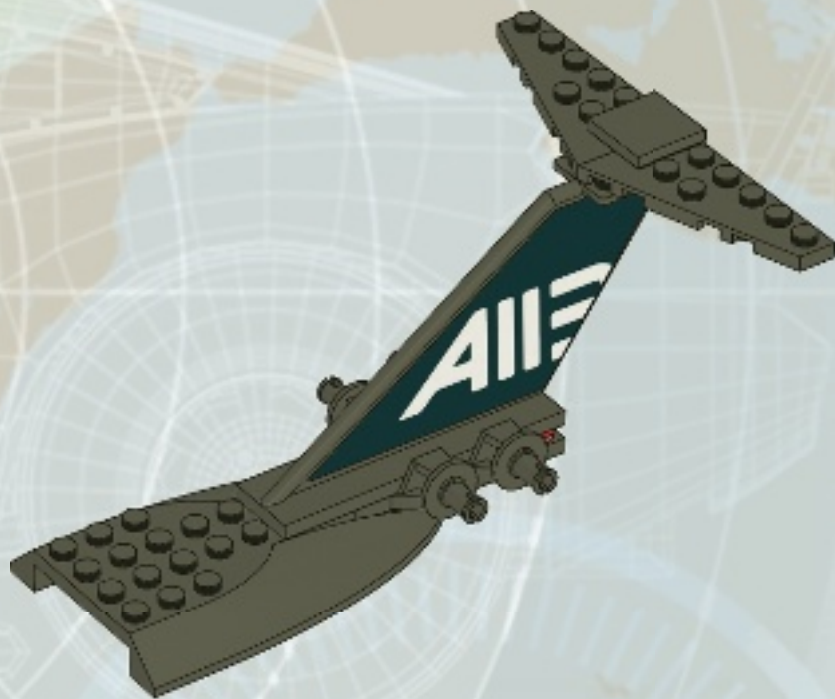

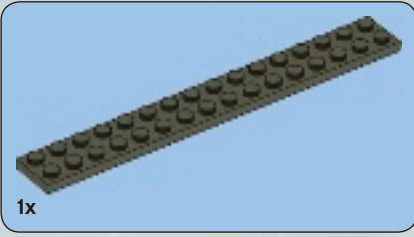

7





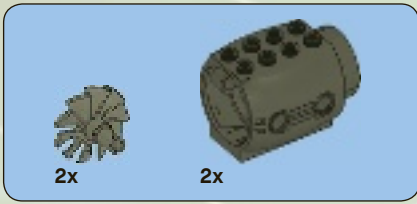

8

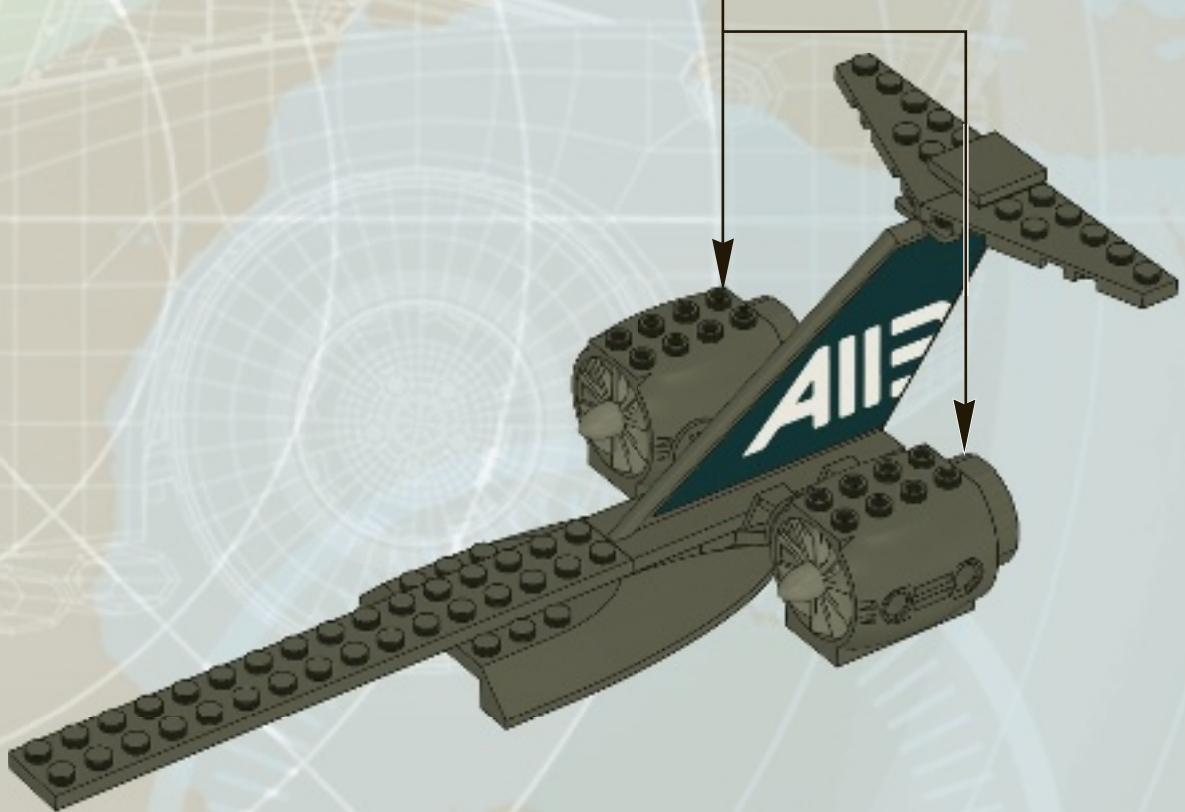
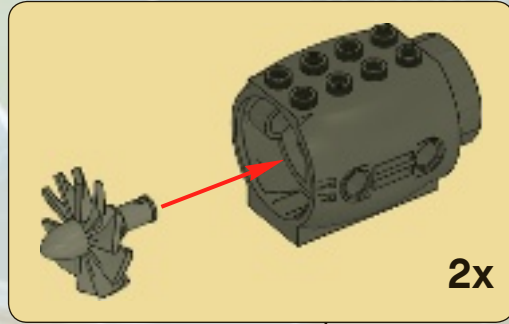

waypoint 1

33

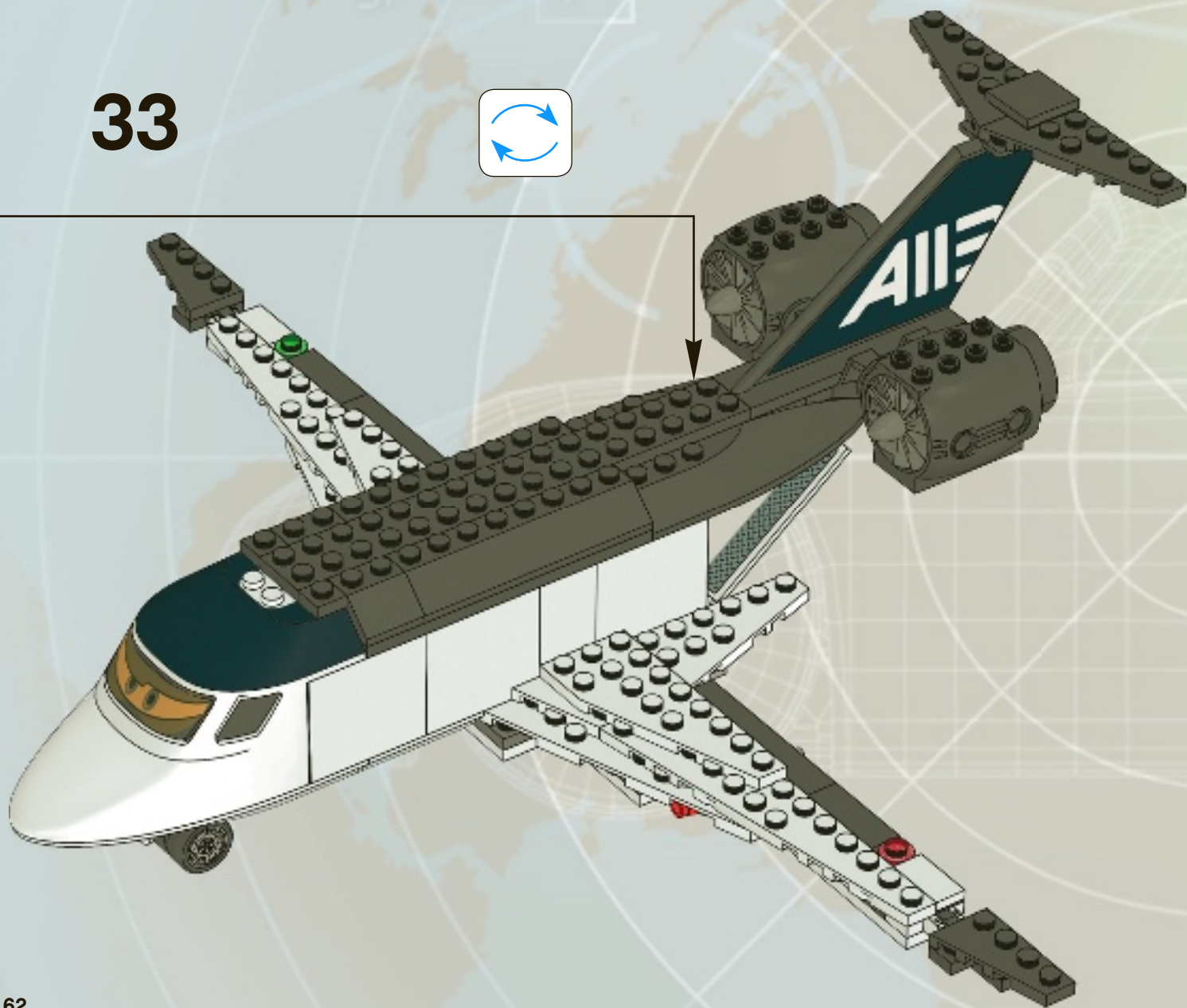

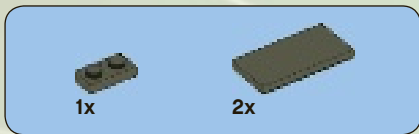

34





35

waypoint 1

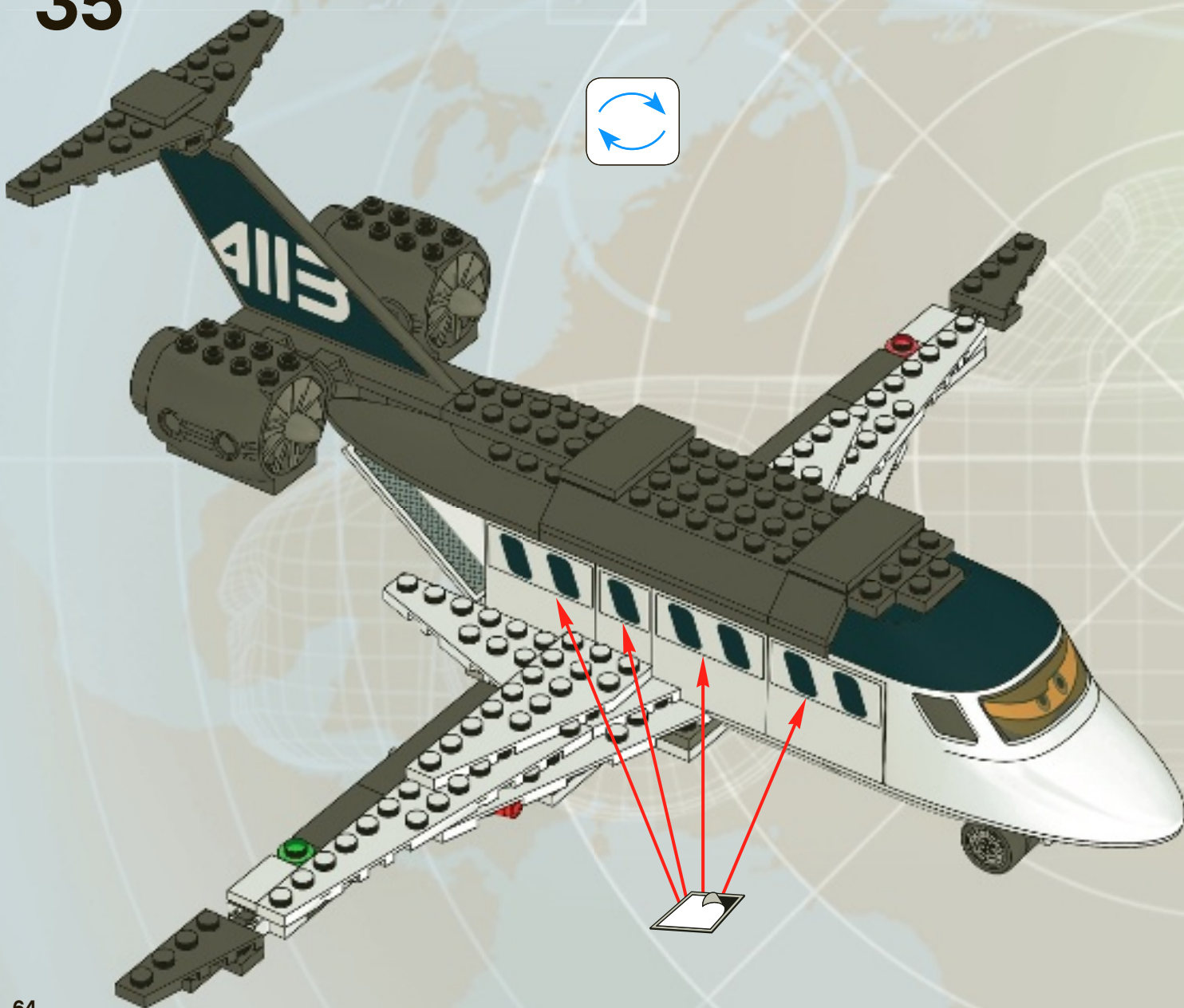



target  
acquired

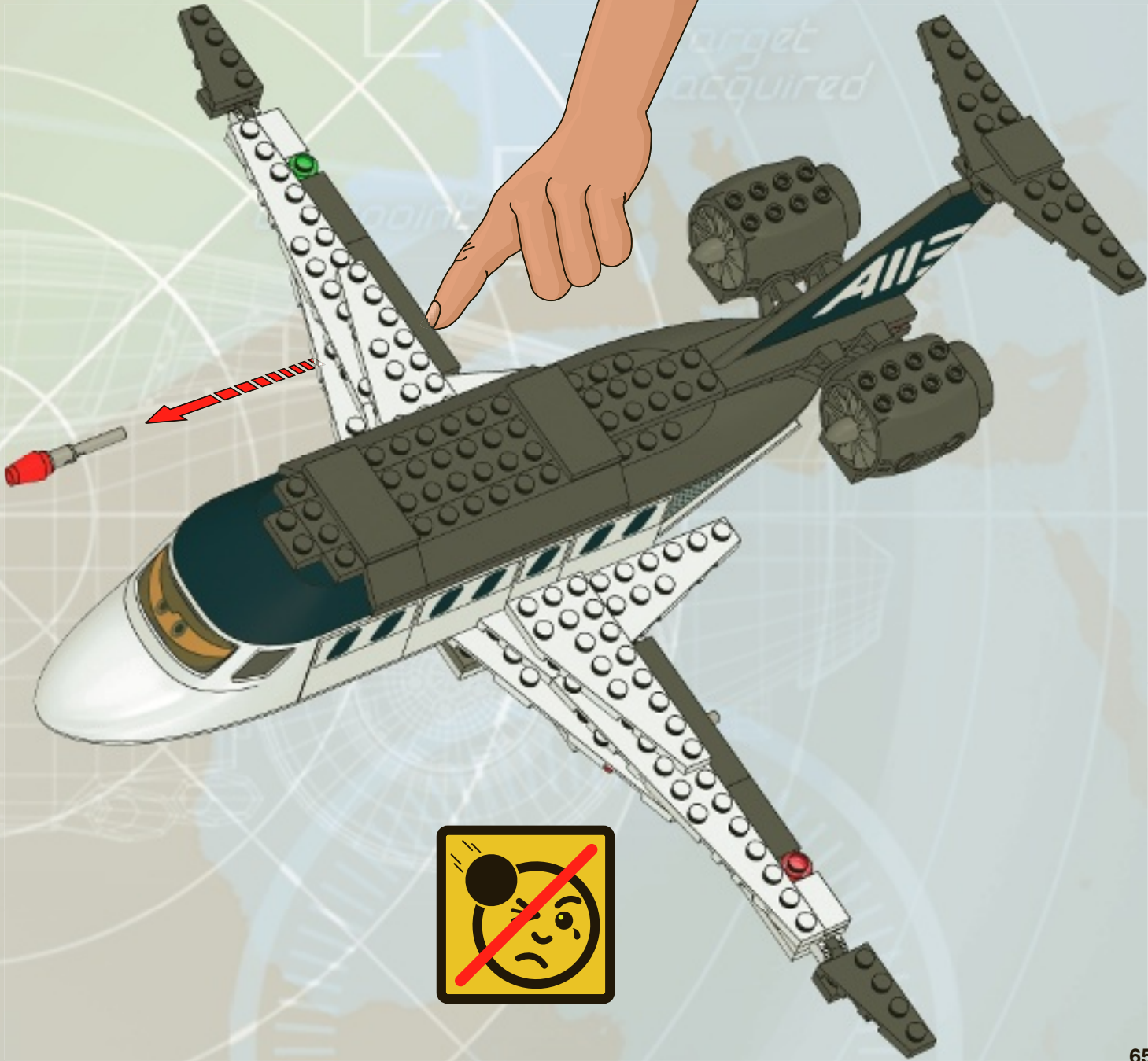

aypoint

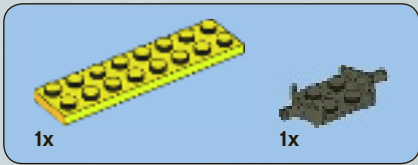

1

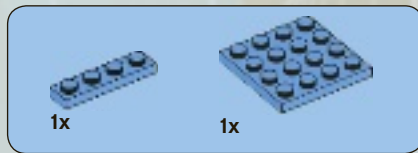
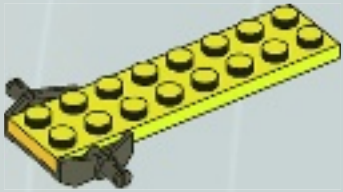

2

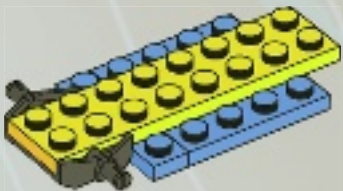

3

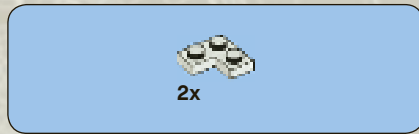
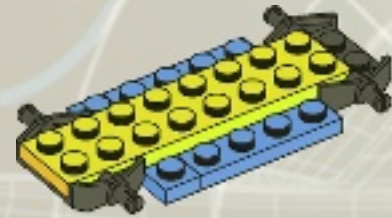

4





5

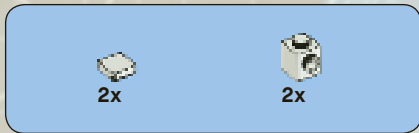

6

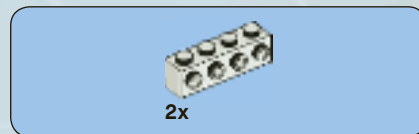
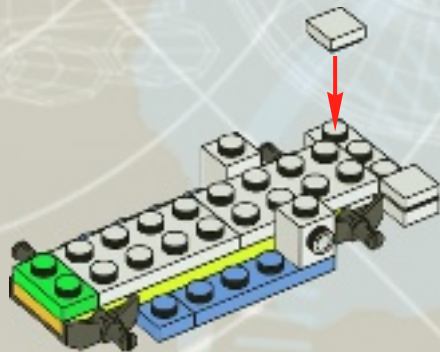

7

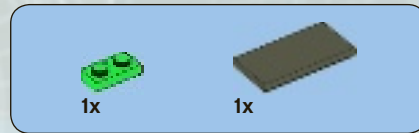
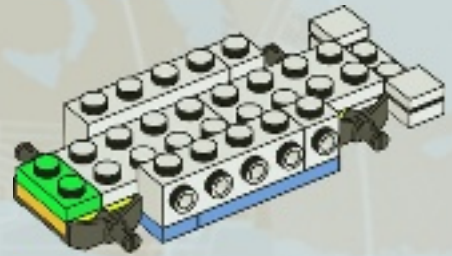

8

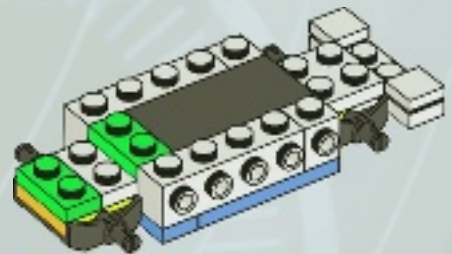





9

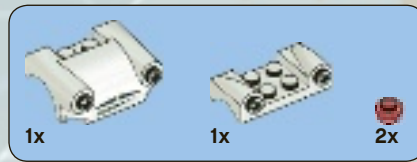
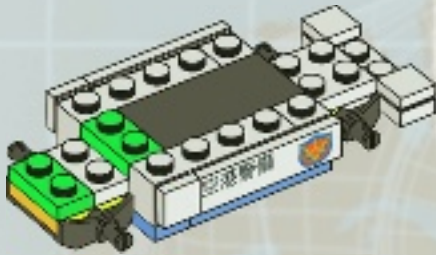

10

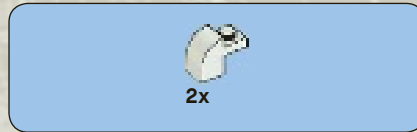
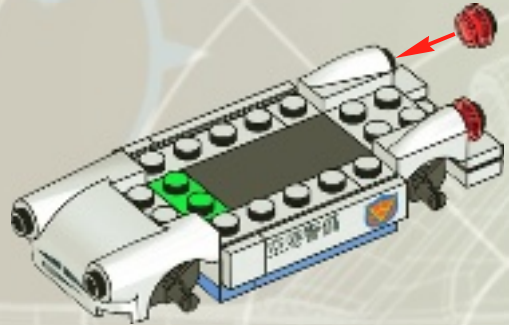

11

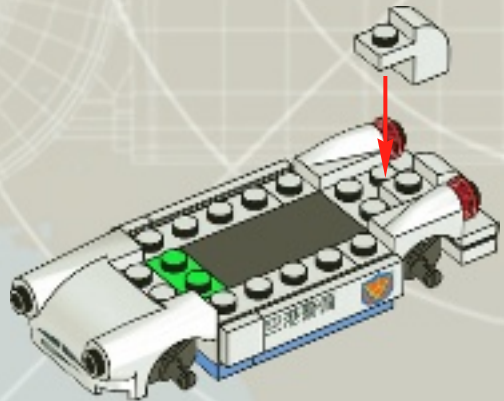





2x



2x

# 12

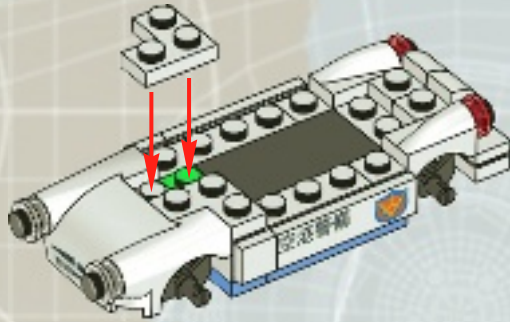

1x

# 13

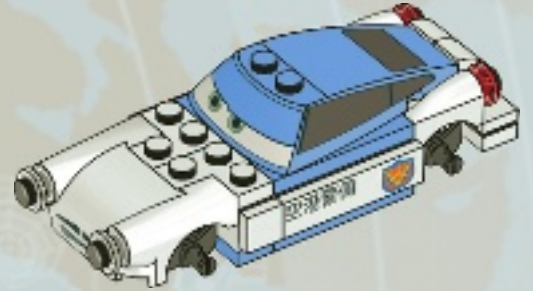

1x



4x



4x

# 14





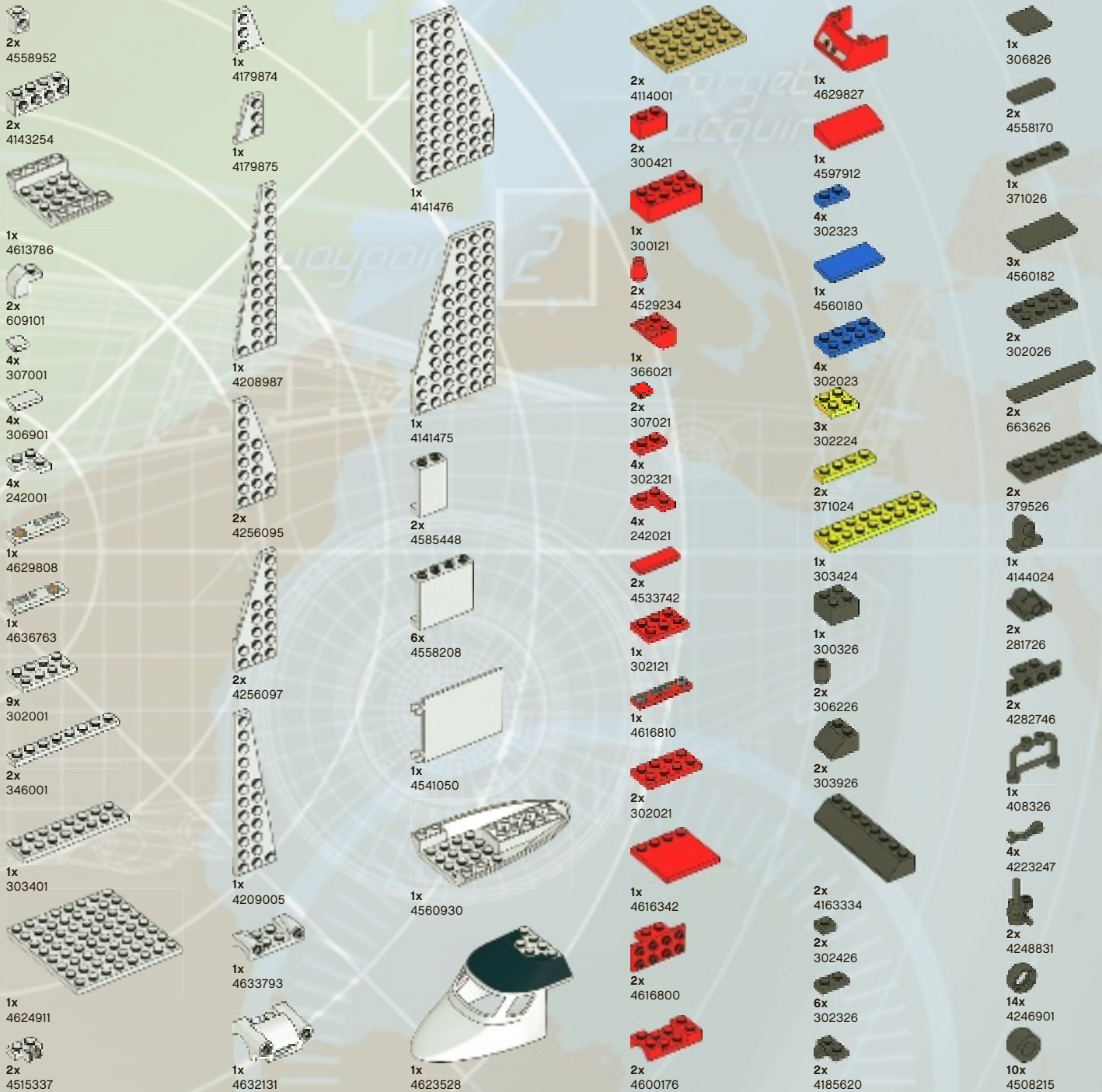





4x  
4616406

2x  
4516843



2x  
447726



2x  
428226



1x  
4623524



1x  
4623525



2x  
4295395



2x  
244126



**Customer Service**

**Kundenservice**

**Service Consommateurs**

**Servicio Al Consumidor**

[www.lego.com/service](http://www.lego.com/service) or dial



00800 5346 5555 :



1-800-422-5346 :



1x  
4283047



1x  
4283046



1x  
4623527



1x  
4160869



1x  
4161332

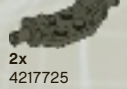

2x  
4217725



2x  
4121715



2x  
4217725



2x  
302328



6x  
3005740

2x  
3000841



1x  
4189801



7x  
3005741



3x  
3005748



1x  
4622713



1x  
4616408



1x  
4179828



1x  
4616698



1x  
4121739



2x  
4211386

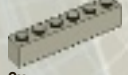

2x  
4211393



2x  
4521921



1x  
4260409



1x  
4211414



3x  
4211397



1x  
4211356



1x  
4211350



2x  
4211516



1x  
4211504



8x  
4211765



10x  
4621178



1x  
4519013



2x  
4520320



1x  
4617072



1x  
4518611



4x  
4633822

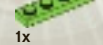

1x  
4187743



1x  
4537936



1x  
4617067

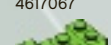

2x  
4600186



1x  
4617076



2x  
4164022



1x  
4617077



2x  
4597561



2x  
4621177



2x  
421182

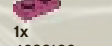

1x  
4623160

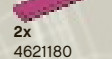

2x  
4621180



1x  
4243826



1x  
4621175



1x  
4621184

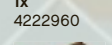

1x  
4222960

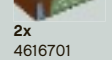

2x  
4616701

2x  
4620075



2x  
4221744



2x  
4211151



1x  
4211152

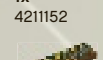

1x  
4616707

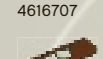

1x  
4620530



2x  
4221590



2x  
4617030



2x  
4616702



2x  
4620534



2x  
4620537

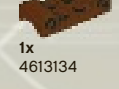

1x  
4613134

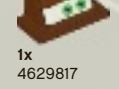

1x  
4629817

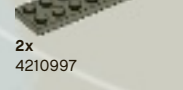

2x  
4210997



2x  
4295253



2x  
4211085



4x  
4211121

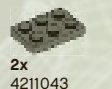

2x  
4211043

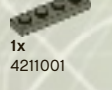

1x  
4211001

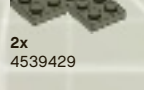

2x  
4539429



2x  
4587212



2x  
4210660



1x  
4620079



2x  
4211051



1x  
4212529

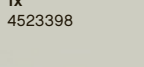

1x  
4523398





**LEGO.com/CARS**



**8639**





8487







[www.LEGOclub.com](http://www.LEGOclub.com)



LEGO® Club Email

**LEGO club**™

**FREE! GRATIS! GRATUIT!**



LEGO® Club Magazine

**SIGN UP ONLINE!**

**[www.LEGOclub.com](http://www.LEGOclub.com)**



**00800 5346 5555\***



**1-866-534-6258 • 1-877-518-5346**

US & Canada only

Canada seulement

\* Freephone. Mobile charges may apply.  
\* Numéro sans frais. Des frais peuvent s'appliquer avec les téléphones cellulaires.  
\* Gebührenfrei, Kosten für Anrufe aus Mobilfunknetzen können abweichen.  
\* Gratis telefonnummer vanaf vaste lijn.  
\* Det er et gratis nummer, når du ringer fra fasttelefon.  
\* Det är gratis, när du ringer från en fast telefon.  
\* Numéro sans frais. Des frais peuvent s'appliquer avec les téléphones portables.





# WIN!

Go to [www.LEGOsurvey.com/product](http://www.LEGOsurvey.com/product) to fill out a survey for a chance to win a cool LEGO® Product.  
No purchase necessary.  
Open to all residents where not prohibited.

 [www.LEGO.com](http://www.LEGO.com)



## [www.LEGOsurvey.com/product](http://www.LEGOsurvey.com/product)

### GEWINNE! WIN!

Nimm an der Umfrage auf [www.LEGOsurvey.com/product](http://www.LEGOsurvey.com/product) teil und hab die Chance ein cooles LEGO® Produkt zu gewinnen!  
Die Teilnahme am Gewinnspiel führt zu keinerlei Kaufverpflichtungen. Teilnahme in allen nicht ausgeschlossenen Ländern möglich.

Ga naar [www.LEGOsurvey.com/product](http://www.LEGOsurvey.com/product), vul een enquêteformulier in en maak kans op een cool LEGO® product.  
Geen aankoopverplichting. Iedereen mag deelnemen, uitgezonderd ingezetenden van landen waar een enquêteverbod geldt.

### GAGNE! 当てよう!

Visite [www.LEGOsurvey.com/product](http://www.LEGOsurvey.com/product) pour répondre à un questionnaire et avoir une chance de gagner un produit LEGO® très cool!  
Aucune obligation d'achat.  
Ouvert à tous les résidents des pays autorisés.

[www.LEGOsurvey.com/product](http://www.LEGOsurvey.com/product) にアクセスして、アンケートにご記入ください。当選者にはレゴ®製品を差し上げます。  
お買い上げの必要はありません。  
禁止されていない限り、すべての皆様にご利用いただけます。

LEGO and the LEGO logo are trademark of the LEGO Group. ©2011 The LEGO Group.  
Les éléments Disney/Pixar : © Disney/Pixar, not including underlying vehicles owned by third parties: Gremlin and Pacer are trademarks of Chrysler LLC  
Elementos Disney/Pixar : © Disney/Pixar, sin incluir los vehiculos subyacentes propiedad de terceros: Gremlin y Pacer son marcas de Chrysler LLC